



**TRAJECTORY TRACKING CONTROL OF FLEXIBLE JOINT PARALLEL
MANIPULATORS SUBJECT TO IMPACT**

MUSTAFA SEMİH DENİZLİ

FEBRUARY 2016

**TRAJECTORY TRACKING CONTROL OF FLEXIBLE JOINT PARALLEL
MANIPULATORS SUBJECT TO IMPACT**

**A THESIS SUBMITTED TO
THE GRADUATE SCHOOL OF NATURAL AND APPLIED
SCIENCES OF
ÇANKAYA UNIVERSITY**

**BY
MUSTAFA SEMİH DENİZLİ**

**IN PARTIAL FULFILLMENT OF THE REQUIREMENTS FOR THE
DEGREE OF
MASTER OF SCIENCE
IN
THE DEPARTMENT OF
MECHANICAL ENGINEERING**

FEBRUARY 2016

Title of the Thesis: **Trajectory Tracking Control of Flexible Joint Parallel Manipulators Subject to Impact**

Submitted by **Mustafa Semih DENİZLİ**

Approval of the Graduate School of Natural and Applied Sciences, Çankaya University.



Prof. Dr. Halil Tanyer Eyyuboğlu
Director

I certify that this thesis satisfies all the requirements as a thesis for the degree of Master of Science.



Prof. Dr. Sıtkı Kemal İDER
Head of Department

This is to certify that we have read this thesis and that in our opinion it is fully adequate, in scope and quality, as a thesis for the degree of Master of Science.

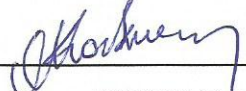

Dr. Ozan KORKMAZ
Co-Supervisor



Prof. Dr. Sıtkı Kemal İDER
Supervisor

Examination Date: 01.02.2016

Examining Committee Members

Prof. Dr. Sıtkı Kemal İDER (Çankaya Univ.)

Asst. Prof. Dr. Özgün SELVİ (Çankaya Univ.)

Assoc. Prof. Dr. Sinan KILIÇASLAN (Gazi Univ.)



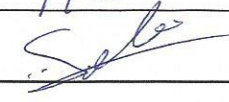

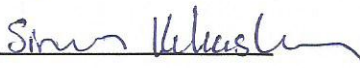

STATEMENT OF NON-PLAGIARISM

I hereby declare that all information in this document has been obtained and presented in accordance with academic rules and ethical conduct. I also declare that, as required by these rules and conduct, I have fully cited and referenced all material and results that are not original to this work.

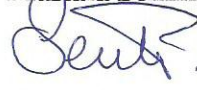
Name, Last Name : Mustafa Semih DENIZLI
Signature : 
Date : 01.02.2016

ABSTRACT

TRAJECTORY TRACKING CONTROL OF FLEXIBLE JOINT PARALLEL MANIPULATORS SUBJECT TO IMPACT

DENİZLİ, Mustafa Semih

M.Sc., Department of Mechanical Engineering

Supervisor: Prof.Dr. Sıtkı Kemal İDER

February 2016, 99 pages

In this study, trajectory tracking control method for parallel manipulators having joint elasticity is examined and in addition the stability and the performance were investigated when the manipulator is subject to an impact with another object. Firstly, dynamic analysis for the parallel manipulators is carried out and the system equations of motion are derived by using Lagrange technique. Then the system impulse-momentum equations are derived. Moreover, an inverse dynamics control method is presented which is based on an input-output relation between the torques and end-effector position variables. In the case study, a 3-RPR planar parallel manipulator with three legs having joint elasticity is simulated considering an impact with a point mass body and all of these simulations are conducted by Matlab[®] and Simulink[®] software programs. After the simulations, it is observed that controller retrieved the desired trajectory and the results are provided at the end of the study.

Keywords: Flexible joint, impact, parallel manipulator, trajectory tracking control.

ÖZ

ÇARPMAYA MARUZ BIRAKILAN ESNEK EKLEMLİ PARALEL MANİPÜLATÖRLERİN YÖRÜNGE TAKİP KONTROLÜ

DENİZLİ, Mustafa Semih

Yüksek Lisans, Makine Mühendisliği Anabilim Dalı

Tez Yöneticisi: Prof .Dr. Sıtkı Kemal İDER

Şubat 2016, 99 sayfa

Bu tez çalışmasında, esnek eklemli paralel manipülatörlerin yörünge takip metodu işlenmiştir ve buna ek olarak paralel manipülatörün bir başka cisimle çarpışmaya maruz bırakıldığı durumdaki sabitlik ve performans incelemeleri yapılmıştır. Öncelikli olarak paralel manipülatörlerin dinamik analizi yapılmış ve hareket denklemleri Lagrange formülasyonu kullanılarak çıkarılmıştır. Daha sonrasında ise impuls-momentum denklemleri elde edilmiştir. Bunlara ek olarak, torklar ve uç işlemci pozisyon değişkenleri arasındaki giriş/çıkış ilişkisine dayanan ters dinamik kontrol metodu işlenmiştir. Durum çalışmasında ise bir başka cisimle çarpmaya maruz bırakılan esnek eklemli üç bacaklı düzlemsel bir paralel manipülatör (döner, prizmatik, döner eklemli) incelenmiştir ve tüm simülasyon çalışmaları Matlab® ve Simulink® programları kullanılarak yürütülmüştür. Simülasyonlar sonucunda istenen yörünge takip edildiği gözlenmiştir ve simülasyon sonuçları çalışmanın sonunda paylaşılmıştır.

Anahtar Kelimeler: Esnek eklem, çarpma, paralel manipülatör, yörünge takip kontrolü.

ACKNOWLEDGEMENTS

I would like to express my sincere gratitude to Prof. Dr. Sitk1 Kemal İDER and Dr. Ozan KORKMAZ for their guidance, criticisms, suggestions, and encouragement through this thesis.

I would also like to thanks to my family for their support and patience.

TABLE OF CONTENTS

STATEMENT OF NON-PLAGIARISM.....	iii
ABSTRACT.....	iv
ÖZ.....	v
ACKNOWLEDGEMENTS.....	vi
TABLE OF CONTENTS.....	vii
LIST OF FIGURES.....	ix
LIST OF TABLES.....	xi
LIST OF ABBREVIATIONS.....	xii

CHAPTERS:

1. INTRODUCTION.....	1
1.1. Literature Search.....	1
1.2. Objective.....	4
1.3. Outline of the Study.....	4
2. DYNAMIC ANALYSIS OF PARALLEL MANIPULATORS.....	6
2.1. Assumptions.....	6
2.2. Flexible Joint Model.....	6
2.3. Generalized Coordinates and Generalized Coordinated Vectors.....	7
2.4. Lagrange Equations.....	8
2.5 Kinematic Energy Expressions.....	9
2.6 Potential Energy Expressions.....	10
2.7 Dissipation Function Expressions.....	11
2.8 System Equations of Motion.....	11
3. IMPACT DYNAMICS.....	15
3.1. Introduction.....	15
3.2. System Impulse-Momentum Equations.....	15
4. MODELLING AND CONTROL OF A 3-RPR FLEXIBLE JOINT PARALEL MANIPULATOR SUBJECT TO AN IMPACT.....	19
4.1. Introduction.....	19

4.2.	Kinetic Energy of the System.....	22
4.3.	Potential Energy of the System.....	30
4.4	Dissipation Function of the System.....	31
4.5	Lagrange Components of Expressions.....	31
4.6	Constraint Equations.....	34
4.7	System Equations of Motion and System Impulse-Momentum Equations	39
4.8	Control Law.....	50
4.9	Simulation Model.....	53
4.10	Initial Values and Desired Trajectory Motion.....	61
4.11	Data.....	63
4.12	Simulations and Results.....	66
5.	CONCLUSION.....	85
	WORKS CITED.....	86
	APPENDIX.....	88

LIST OF FIGURES

FIGURES

Figure 1	Dynamic Model of the Flexible Joint.....	6
Figure 2	A 3-RPR Planar Parallel Manipulator.....	19
Figure 3	Loop Subspaces and Joint Degree of Freedoms	21
Figure 4	First Leg and Its Link Components.....	22
Figure 5	Second Leg and Its Link Components.....	24
Figure 6	Third Leg and Its Link Components.....	25
Figure 7	Link 7 and Its Link Components.....	26
Figure 8	Link Lengths and Dimensions.....	35
Figure 9	Point of Contact.....	43
Figure 10	Position of the End-Effector.....	48
Figure 11	Overview of the Control Model.....	54
Figure 12	Command Input Block.....	55
Figure 13	Computed Torque Block.....	56
Figure 14	Forward Dynamics Block.....	58
Figure 15	Impact Block.....	59
Figure 16	act_2_eta Block.....	60
Figure 17	Subsystem Block.....	60
Figure 18	Forward Kinematics Block.....	61
Figure 19	Position Response (x_G and y_G).....	66
Figure 20	Position Response (θ_7).....	66
Figure 21	Velocity Response (\dot{x}_G and \dot{y}_G).....	67
Figure 22	Velocity Response ($\dot{\theta}_7$).....	67
Figure 23	Deflections: 1) $\theta_1 - \phi_1$ 2) $\theta_3 - \phi_3$ 3) $\theta_5 - \phi_5$	68
Figure 24	Control Torques.....	68
Figure 25	Position Response (x_G and y_G).....	69
Figure 26	Position Response (θ_7).....	69
Figure 27	Velocity Response (\dot{x}_G and \dot{y}_G).....	70
Figure 28	Velocity Response ($\dot{\theta}_7$).....	70

Figure 29	Deflections: 1) $\theta_1 - \phi_1$ 2) $\theta_3 - \phi_3$ 3) $\theta_5 - \phi_5$	71
Figure 30	Control Torques.....	71
Figure 31	Position Response (x_G and y_G).....	72
Figure 32	Position Response (θ_7).....	72
Figure 33	Velocity Response (\dot{x}_G and \dot{y}_G).....	73
Figure 34	Velocity Response ($\dot{\theta}_7$).....	73
Figure 35	Deflections: 1) $\theta_1 - \phi_1$ 2) $\theta_3 - \phi_3$ 3) $\theta_5 - \phi_5$	74
Figure 36	Control Torques.....	74
Figure 37	Position Response (x_G and y_G).....	75
Figure 38	Position Response (θ_7).....	75
Figure 39	Velocity Response (\dot{x}_G and \dot{y}_G).....	76
Figure 40	Velocity Response ($\dot{\theta}_7$).....	76
Figure 41	Deflections: 1) $\theta_1 - \phi_1$ 2) $\theta_3 - \phi_3$ 3) $\theta_5 - \phi_5$	77
Figure 42	Control Torques.....	77
Figure 43	Position Response (θ_1).....	78
Figure 44	Position Response (θ_3)	78
Figure 45	Position Response (θ_5)	79
Figure 46	Position Response (θ_7)	79
Figure 47	Position Response (ξ_2)	80
Figure 48	Position Response (ξ_4)	80
Figure 49	Position Response (ξ_6)	81
Figure 50	Velocity Response ($\dot{\theta}_1$)	81
Figure 51	Velocity Response ($\dot{\theta}_3$)	82
Figure 52	Velocity Response ($\dot{\theta}_5$)	82
Figure 53	Velocity Response ($\dot{\theta}_7$)	83
Figure 54	Position Response ($\dot{\xi}_2$)	83
Figure 55	Position Response ($\dot{\xi}_4$)	84
Figure 56	Position Response ($\dot{\xi}_6$)	84

LIST OF TABLES

TABLES

Table 1	Feedback Gains.....	63
Table 2	Dimensions and Angles	64
Table 3	Link Masses, Mass of the Colliding Body, Link Inertias and Rotor Inertias.....	64
Table 4	Gear Ratios	64
Table 5	Damping and Spring Constants	65
Table 6	Velocity Components of the Colliding Body and Coefficient of Restitution.....	65

LIST OF ABBREVIATIONS

RRR	Revolute Revolute Revolute Joint
RPR	Revolute Prismatic Revolute Joint
ITAE	Integral of Time Multiplied by the Absolute Value of Error
ess	Steady State Error

CHAPTER 1

INTRODUCTION

1.1 Literature Search

Manipulators are assistive mechanical structures that help the operators to carry heavy loads or to perform a task repetitively and they are classified by their kinematic structures as a serial manipulator having an open loop chain, a parallel manipulator having a closed loop chain and a hybrid manipulator having both open and closed loop chains together. Parallel manipulators, sometimes called platform manipulators, are examined in many researches and there are numerous industrial and medical applications using parallel manipulators since they can carry heavier loads with high accuracy compared to serial manipulators due to their structure. Airplane and earthquake simulators, welding machines, adjustable articulated trusses, mining machines and computer-assisted surgery robots can be listed as some of these applications. Nevertheless there are major problems such as relatively small workspace, design and control difficulties [1].

According to Good et al. [2] joint flexibility should be taken into consideration to prevent performance loss in controller design. Besides, flexible joints can be used in manipulators in the presence of impact in order to decrease the effect of the impact. Transmission elements, couplings and harmonic drives can be the source of this joint elasticity.

In many studies joint flexibility is included in the control of manipulators. Spong [3] presented a dynamic model of flexible joint robot manipulators and studied its control. His model includes joint elasticity and dynamic coupling between the actuators and the links and this study is considered as a significant tractable model.

Forrest-Barlach and Babcock [4] studied the effects of drive train compliance for cylindrical arm mechanism and developed a position controller using inverse dynamics control. The inverse dynamic control method, sometimes referred as computed torque method, is widely used in studies involving dynamics and control of a parallel manipulator and it is also used in my thesis study. Method is based on eliminating intermediate variables and creating a relation between input torques and end-effector position variables in forth order level.

Another study involving an inverse dynamics control of flexible-joint robots is carried out by Jankowski and Van Brussel [5]. In their study, dynamical model for a flexible-joint manipulator, which is derived from significant models examined previously, is used in non-differentiated form and inverse dynamics control method is utilized for discrete time in order to reduce the complexity of the computation which is considered as one of the main disadvantages of using an inverse dynamics control method.

İder [6] presented an inverse dynamics control method for constrained flexible-joint manipulators involving joint structural damping to derive a hybrid force and motion trajectory tracking control law. In this study, implicit numerical integration methods are used to solve singular set of higher order differential equations since this model is based on acceleration level inverse dynamics equations.

İder and Özgören [7] studied the inverse dynamics control method in order to propose a trajectory tracking control law for flexible-joint manipulators.

Parallel manipulators are one of the most studied research topics in robotics and all of the studies mentioned here so far only include serial manipulators.

İder and Korkmaz [8] applied inverse dynamics control method in order to achieve trajectory tracking control of flexible-joint parallel manipulators including structural damping. In this study, dynamic equations are derived by disconnecting tolerable number of unactuated joints in order to obtain an open-tree structure. After getting acceleration level inverse dynamics equations, intermediate variables are eliminated and input-output relation between the torque and actuated joint variables is found. 2-RRR planar manipulator is examined in the case study in order to verify the algorithm.

İder [9] derived an inverse dynamics algorithm with singularity robustness and examined a planar 2-RPR parallel manipulator that is considered as a manipulator having minimal interference which enables more functional workspace. High-order derivative information is used in order to modify dynamic equations due to prevent possible problems in ill condition of force coefficient matrix.

İder and Korkmaz [10] studied inverse dynamics control method and examined hybrid force and control of parallel manipulators in the presence of joint flexibility.

Kılıçaslan [11] presented a control method involving a state-dependent Riccati equation to control elastic-joint parallel manipulators and examined a 2-RRR planar parallel manipulator to check the effectiveness of the method derived in the study.

As it mentioned before, parallel manipulators are widely used in industrial and medical applications and a collision with another object(s) can occur during the process since the environment is not a closed system. Usually impacts, which are the most common type of dynamic loading conditions, are unexpected conditions and those impulsive forces can suppress other forces. Both jumps in system velocities and bumps in positions occur which is considered as a difficult condition to control. Since accuracy is essential during operations especially in a surgery operation, impact phenomena is needed to be focused on. All of the studies mentioned so far does not concerned with a manipulator subjected to an impact.

Haug and Wehage [12] carried out dynamic analysis for systems including impulsive forces and impact and derived the equations of motion and impulse-momentum relations. In the case study, a weapon mechanism and a trip plow is examined.

İlkay [13] examined flexible multi-body mechanical systems and presented an impact dynamics model in order to observe the impact response. Generalized impulse momentum equations are used but with assumptions of short-term impulse and constant coefficient of restitution during impact time. A slider-crank mechanism, a sliding cantilever beam with a rigid rod attached to the tip and a cantilever beam with a tip-point mass are studied in the case study.

Liu et al. [14] studied impact dynamics and control of a flexible dual-arm space robot which is carrying out a capturing operation. The motivation of this study is to investigate the effect of payload collision due to capturing an object. The dynamic model is presented using Lagrange formulation and a PD controller is designed since control of space manipulators is difficult in the meaning of stabilization.

Gherman et al. [15] studied kinematics and dynamics of a parallel hybrid surgical robot and applied inverse dynamic control.

Angeles and Zhang [16] analyzed the dynamics of a flexible-joint manipulator subjected to an impact. Impulse potential energy and generalized impulse momentum equations are derived with the assumptions of infinitesimal impact time, unchanged body positions during impact, point-touch impact and unchanged body inertias. A 2-link flexible revolute joint manipulator is examined in the case study.

Qian and Zhang [17] studied the dynamics of multi-link manipulators subject to an impact in the presence of link and joint flexibility. Links are considered as Euler-Bernoulli beams. After getting dynamic equations, a mathematical model is formed and impact forces are examined. A spatial manipulator including both flexible link and flexible joint is examined to verify the model.

Zhang et al. [18] presented a continuous contact model including a space manipulator colliding with a soft environment. Due to the soft environment, it is stated that collision time cannot be considered as instant so that a continuous model is needed to be studied. Hence continuous force is taken into consideration as a collision force. The model is derived considering Hertz law including hysteresis damping. A 7-dof space manipulator subject to an impact with a free-floating object is examined to observe the effects of collision.

1.2 Objective

The main objective of this study is to achieve a trajectory tracking control of a flexible-joint parallel manipulator subjected to an impact with another point mass object during its process. After the system equations of motion derived by using Lagrange formulation, intermediate variables are eliminated and the control law is derived. System impulse-momentum equations are also derived. During the simulation time, control torque data, end-effector position data, end-effector velocity data, joint position data, joint velocity data and angular position of the actuator rotor data are collected and the corresponding plots are drawn.

1.3 Outline of the Study

This study, containing five chapters, aims to examine the dynamics and control of a parallel manipulator subjected to an impact step by step including a case study.

Chapter 1 is the introduction part, presenting a brief history of studies carried out before related with parallel manipulators, joint flexibility and impact. The objective of this study is also being mentioned in this part.

In Chapter 2, the basic assumptions that are taken into consideration in the dynamic model and the concept of flexible joint are presented. Then Lagrange equations and energy expressions are mentioned. Lastly, system equations of motion for a parallel manipulator are derived.

Chapter 3 addresses the impact dynamics. The assumptions are mentioned at the beginning of this chapter and then the system impulse-momentum equations are presented.

In Chapter 4 a series of simulation studies are carried out involving a 3-RPR parallel flexible-joint manipulator which collides with an object during its process. The same procedures followed in the previous chapters are also valid in this example. First of all, the dynamic model of the manipulator is investigated and then system impulse-momentum equations are derived. After that the governing control law is derived and the simulation model is presented. Lastly, simulations are carried out and the results are given.

Chapter 5 is the conclusion part including a summary of this thesis study, comments about the simulation results and proposals for the further studies.

CHAPTER 2

DYNAMIC ANALYSIS OF PARALLEL MANIPULATORS

2.1 Assumptions

Spong states two major assumptions for a dynamic model of the flexible joint robot manipulators [3] which can be listed as,

1. Rotation of the rotor itself is the source of rotor kinetic energy.
2. Rotor inertia is symmetric about the axis of rotor rotation.

In this study there are also two additional assumptions taken into consideration in the dynamic analysis,

1. All of the links in the system are rigid links.
2. Viscous damping in the joints and the rotor dampings are ignored.

2.2 Flexible Joint Model

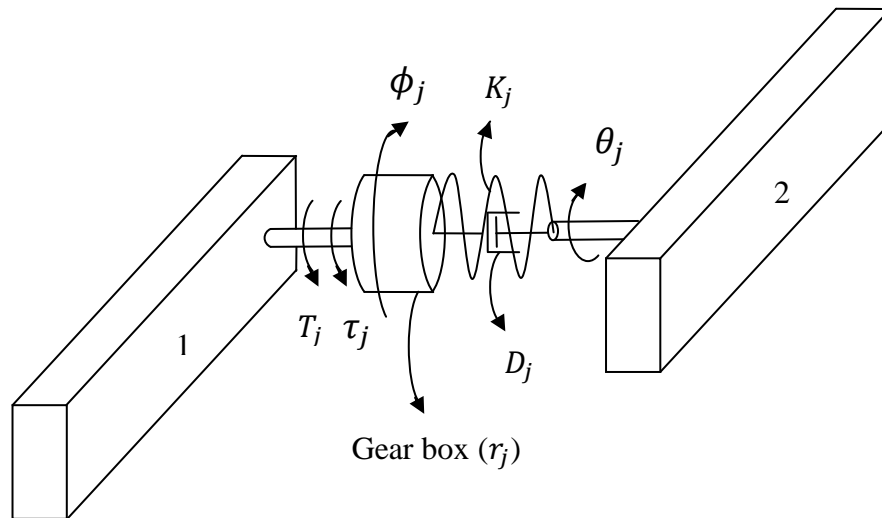

Figure 1 Dynamic Model of the Flexible Joint

Dynamic model of a flexible joint is shown in Figure 1. As it is seen in the figure, actuator is placed on link-1 and link-2 is driven by link.

Joint elasticity is modeled as torsional spring, where K_j represents the spring constant and damping is modeled as torsional damper, where D_j is the damping constant. θ_j is the angular position of the driven link. r_j is the ratio of speed reduction and τ_j is the actuator variable which will all be explained in details in further Section 2.8.

2.3 Generalized Coordinates and Generalized Coordinates Vectors

Parallel manipulators are closed-loop structures and in the dynamic analysis of parallel manipulators, sufficient numbers of joints are disconnected for the simplicity in order to have an open-tree system. In an open-tree system with m degree of freedom, the first set of generalized coordinates including the joint variables can be written as,

$$G_1 = \{\theta_1, \theta_2, \dots, \theta_m\} \quad (2.1)$$

The vector of generalized coordinates corresponding to the joint variables, which are basically the relative positions of the joints, can be expressed as,

$$\bar{\eta} = [\theta_1, \theta_2, \dots, \theta_m]^T \quad (2.2)$$

where m is the number of joints in the system.

The expression in Equation 2.2 includes both actuated and unactuated joint variables.

The second set of generalized coordinates including the actuator variables are defined as,

$$G_2 = \{\phi_1, \phi_2, \dots, \phi_n\} \quad (2.3)$$

where n is the number of actuators in the system which is equal to the degree of freedom of the robot.

Equation 2.3 implies that the vector of second generalized coordinates is the following,

$$\bar{\phi} = [\phi_1, \phi_2, \dots, \phi_n]^T \quad (2.4)$$

2.4 Lagrange Equations

The general form of the Lagrange equation can be written as,

$$\frac{d}{dt} \left(\frac{\partial K}{\partial \dot{x}_k} \right) - \frac{\partial K}{\partial x_k} + \frac{\partial P}{\partial x_k} = f'_k \quad (2.5)$$

where

- K is the total kinetic energy of the system
- P is the total potential energy of the system
- f'_k is the non-potentialized generalized forces

According to Equation (2.5), Lagrange equation for the first set of generalized coordinates can be written as,

$$\frac{d}{dt} \left(\frac{\partial K}{\partial \dot{\theta}_i} \right) - \frac{\partial K}{\partial \theta_i} + \frac{\partial P}{\partial \theta_i} + \frac{\partial D}{\partial \dot{\theta}_i} = f'_i + f''_i \quad i = 1, \dots, m \quad (2.6)$$

where

- D is the total dissipation function of the system
- f'_i is the non-potentialized generalized forces due to drive trains
- f''_i is the generalized constraint forces due to disconnecting the joints

With the same methodology, Lagrange equation for the second set of generalized coordinates, the actuator variables, is the following,

$$\frac{d}{dt} \left(\frac{\partial K}{\partial \dot{\phi}_j} \right) - \frac{\partial K}{\partial \phi_j} + \frac{\partial P}{\partial \phi_j} + \frac{\partial D}{\partial \dot{\phi}_j} = f'_j \quad j = 1, \dots, n \quad (2.7)$$

f'_j represents the non-potentialized generalized forces for the second set of generalized coordinates.

2.5 Kinetic Energy Expressions

As it mentioned before, Lagrange equations include kinetic energy terms. Hence, kinetic energy expressions for both links and actuators are needed to be found.

Kinetic energy expression for each link in the system can be formulated as,

$$KE_i^L = \frac{1}{2} m_i^L (\vec{V}_{Gi}^L)^T \vec{V}_{Gi}^L + \frac{1}{2} (\vec{\omega}_i^L)^T \hat{I}_i^L \vec{\omega}_i^L \quad i = 1, \dots, m \quad (2.8)$$

m_i^L is the mass of i-th link

\vec{V}_{Gi}^L is the velocity vector of mass center of the i-th link due to fixed reference frame

$\vec{\omega}_i^L$ is the angular velocity vector of the i-th link due to fixed reference frame

\hat{I}_i^L is the moment of inertia matrix of the i-th link due to fixed reference frame

Contributing terms in Equation (2.8), which are the vector of translational velocity and the vector of angular velocity, can be explicitly written as the following,

$$\vec{V}_{Gi}^L = \sum_{k=1}^m \vec{\Pi}_{ik}^L \dot{\theta}_k \quad i = 1, \dots, m \quad (2.9)$$

$$\vec{\omega}_i^L = \sum_{k=1}^m \vec{\Psi}_{ik}^L \dot{\theta}_k \quad i = 1, \dots, m \quad (2.10)$$

$\vec{\Pi}_{ik}^L$ is the influence coefficient vector corresponding to the velocity vector

$\vec{\Psi}_{ik}^L$ is the influence coefficient vector corresponding to the angular velocity vector

Kinetic energy expression for each actuator in the system can be formulated as,

$$KE_j^A = \frac{1}{2} m_j^A (\vec{V}_{Gj}^A)^T \vec{V}_{Gj}^A + \frac{1}{2} (\vec{\omega}_j^A)^T \hat{I}_j^A \vec{\omega}_j^A \quad j = 1, \dots, n \quad (2.11)$$

m_j^A is the mass of j-th actuator

\vec{V}_{Gj}^A is the velocity vector of mass center of the j-th actuator due to fixed reference frame

$\vec{\omega}_j^A$ is the angular velocity vector of the j-th actuator due to fixed reference frame

\hat{I}_j^A is the moment of inertia matrix of the j-th actuator due to fixed reference frame

Contributing terms in Equation (2.11), which are the vector of translational velocity and the vector of angular velocity, can be explicitly written as the following,

$$\vec{V}_{Gj}^A = \sum_{k=1}^m \vec{\Pi}_{jk}^A \dot{\theta}_k \quad j = 1, \dots, n \quad (2.12)$$

$$\vec{\omega}_j^A = \sum_{k=1}^m \vec{\Psi}_{jk}^A \dot{\theta}_k \quad j = 1, \dots, n \quad (2.13)$$

$\vec{\Pi}_{jk}^A$ is the influence coefficient vector corresponding to the velocity vector

$\vec{\Psi}_{jk}^A$ is the influence coefficient vector corresponding to the angular velocity vector

Thus, the total kinetic energy of the system equals to,

$$KE_{Total} = \sum_{k=1}^m KE_k^L + \sum_{k=1}^n KE_k^A \quad (2.14)$$

2.6 Potential Energy Expressions

Lagrange equations also include potential energy expressions for both links and actuators.

Potential energy expression for each link in the system can be formulated as,

$$PE_i^L = -\vec{g}^T m_i^L \vec{r}_i^L \quad i = 1, \dots, m \quad (2.15)$$

\vec{g}^T is the transpose of the vector of gravitational acceleration

m_i^L is the mass of the i-th link

\vec{r}_i^L is the position vector of the center of mass of the i-th link due to fixed reference frame

In similar manner potential energy of each actuator is,

$$PE_j^A = -\vec{g}^T m_j^A \vec{r}_j^A + \frac{1}{2} K_j (\phi_j - \theta_j)^2 \quad j = 1, \dots, n \quad (2.16)$$

\vec{g}^T is the transpose of the vector of gravitational acceleration

m_j^A is the mass of the j-th actuator

K_j is the joint spring constant for the j-th transmission

Sum of Equation (2.15) and Equation (2.16) will give the total potential energy of the system which is,

$$PE_{Total} = \sum_{k=1}^m PE_k^L + \sum_{k=1}^n PE_k^A \quad (2.17)$$

2.7 Dissipation Function Expressions

Since viscous damping and rotor damping are neglected, the main source of the dissipative function is the structural damping in the actuated joints, which can be formulated as,

$$D^a = \frac{1}{2} \sum_{j=1}^n D_j^a (\dot{\theta}_j - \dot{\phi}_j)^2 \quad (2.18)$$

where

D_j^a is the damping constant of structural damping in the j-th actuated joint.

2.8 System Equations of Motion

As it mentioned before in Section 2.3, there are two major types of generalized forces for a parallel manipulator system; non-potentialized forces and constraint forces. Applying virtual work method, which is one of the basic energy methods, for each set of generalized coordinates, non-potentialized forces would be found.

Since there is no external generalized forces in the system, the virtual work expression for the first set of generalized coordinate is the following,

$$\delta W_i' = 0 \quad i = 1, \dots, m \quad (2.19)$$

Actuator variables is the torques after speed reduction thus, the virtual work expression for the second set of generalized coordinate is written as,

$$\delta W_j' = T_j \delta \phi_j \quad j = 1, \dots, n \quad (2.20)$$

In Equation (2.20) T_j represents control torque which can be denoted as,

$$T_j = r_j T_j^a \quad j = 1, \dots, n \quad (2.21)$$

T_j^a is torque supplied by the j-th actuator

r_j is speed reduction ratio of the j-th flexible joint

The speed reduction ratio, r_j , is the ratio of angular position of the j-th actuator's rotor with respect to the link to the angles [19], which is written explicitly as the following,

$$r_j = \frac{\tau_j}{\phi_j} \quad j = 1, \dots, n \quad (2.22)$$

According to Equation (2.19) and Equation (2.20), non-potentialized forces corresponding to the first and second generalized coordinates are derived respectively as,

$$f_i' = 0 \quad i = 1, \dots, m \quad (2.23)$$

$$f_j' = T_j \quad j = 1, \dots, n \quad (2.24)$$

Since there are m-n number of closure constraint equations after disconnecting sufficient numbers of joints, virtual work expression corresponding to those constraint equations at the velocity level is the following,

$$\sum_{i=1}^m B_{ji} \delta \dot{\theta}_i = 0 \quad j = 1, \dots, (m - n) \quad (2.25)$$

Integrated form of Equation (2.25) can be written in terms of constraint reaction forces, λ_j , which is,

$$\sum_{j=1}^{m-n} \lambda_j [\sum_{i=1}^m B_{ji} \delta \theta_i] = 0 \quad j = 1, \dots, (m - n) \quad (2.26)$$

Thus, constraint forces would be equal to the following equation,

$$f_i'' = \sum_{j=1}^{m-n} B_{ji} \lambda_j \quad j = 1, \dots, (m - n) \quad (2.27)$$

When the related formulas derived so far are plugged into the Lagrange equations (see Equation 2.6 and Equation 2.7), it yields two major sets of equations of motion for the first set of generalized coordinates and the second set of generalized coordinates which can be shown respectively as,

$$\sum_{k=1}^m M_{ik} \ddot{\eta}_i + Q_i + D_i + K_i - \sum_{k=1}^{m-n} \lambda_k B_{ki} = 0 \quad i = 1, \dots, m \quad (2.28)$$

$$I_j^r r_j^2 \ddot{\phi}_j - D_j(\dot{\theta}_j - \dot{\phi}_j) - K_j(\theta_j - \phi_j) = T_j \quad j = 1, \dots, n \quad (2.29)$$

Equation (2.28) can be written in matrix form as,

$$\widehat{M}^r \ddot{\vec{\eta}} + \vec{Q} + \vec{D} + \vec{K} - \widehat{B}^{RT} \vec{\lambda} = 0 \quad (2.30)$$

where

- \widehat{M}^r is the $m \times m$ symmetric positive definite generalized mass matrix
- $\ddot{\vec{\eta}}$ is the $m \times 1$ acceleration vector including both actuated and unactuated joint variables
- \vec{Q} is the $m \times 1$ vector including centrifugal, gravitational and coriolis terms
- \vec{D} is the $m \times 1$ vector including damping terms
- \vec{K} is the $m \times 1$ vector including stiffness terms
- \widehat{B}^{RT} is the transpose of the $(m - n) \times m$ constraint matrix
- $\vec{\lambda}$ is the $(m - n) \times 1$ vector including constraint forces

Equation (2.29) can be written as,

$$\hat{I}^r \ddot{\vec{\phi}} - \hat{D}^a (\dot{\vec{\eta}}^a - \dot{\vec{\phi}}) - \hat{K}(\vec{\eta}^a - \vec{\phi}) = \vec{T} \quad (2.31)$$

where

\hat{I}^r is the $n \times n$ diagonal matrix including the inertial terms of links

\hat{D}^a is the $n \times n$ diagonal matrix including the inertial terms of actuated variables

$\dot{\vec{\eta}}^a$ is the $n \times 1$ velocity vector including actuated joint variables

\hat{K} is the $n \times n$ diagonal matrix including spring constants

\vec{T} is the $n \times 1$ vector of control torques

CHAPTER 3

IMPACT DYNAMICS

3.1 Introduction

It is considered that during an ongoing process, a point mass collides the manipulator.

Likewise in the dynamic model of the flexible joint presented in Section 2.1, there are essential assumptions taken into consideration in impact dynamics [13] which are the followings,

1. Impact time is so short so that large impacting forces come up and positions do not change during the collision time
2. Coefficient of restitution is constant during the collision time.

3.2 System Impulse-Momentum Equations

The combined equation of both manipulator and colliding body can be written as,

$$\hat{M}\ddot{\bar{\mu}} + \bar{Q} + \bar{D} + \bar{K} - \hat{B}^T \bar{\lambda} + \bar{F}^p = 0 \quad (3.1)$$

where

\hat{M} is $(m + 2) \times (m + 2)$ mass matrix of the combined system including both $(m \times m)$ mass matrix of the manipulator and (2×2) mass matrix of the colliding body

$\ddot{\bar{\mu}}$ is $(m + 2) \times 1$ vector containing acceleration expressions of both manipulator joint variables and the colliding body

\hat{B}^T is the transpose of the $(m - n) \times (m + 2)$ constraint matrix

\bar{F}^p is the vector of generalized impulsive forces during the impact

When Equation 3.1 and Equation 2.31 are integrated with respect to time,

$$\int_{\tau^-}^{\tau^+} \widehat{M} \ddot{\vec{\mu}} dt + \int_{\tau^-}^{\tau^+} \vec{Q} dt + \int_{\tau^-}^{\tau^+} \vec{D} dt + \int_{\tau^-}^{\tau^+} \vec{K} dt - \int_{\tau^-}^{\tau^+} \widehat{B}^T \vec{\lambda} dt + \int_{\tau^-}^{\tau^+} \vec{F}^p dt = 0 \quad (3.2)$$

$$\int_{\tau^-}^{\tau^+} \widehat{I}^r \ddot{\vec{\phi}} dt - \int_{\tau^-}^{\tau^+} \widehat{D}^a (\dot{\vec{\eta}}^a - \dot{\vec{\phi}}) dt - \int_{\tau^-}^{\tau^+} \widehat{K} (\vec{\eta}^a - \vec{\phi}) dt = \int_{\tau^-}^{\tau^+} \vec{T} dt \quad (3.3)$$

Mean value theorem is used and since it is assumed that during impact applied forces are considered as continuous and velocities are bounded, limits of integration for the following terms are zero: \vec{Q} , \vec{D} , \vec{K} , $\widehat{D}^a (\dot{\vec{\eta}}^a - \dot{\vec{\phi}})$, $\widehat{K} (\vec{\eta}^a - \vec{\phi})$ and \vec{T} .

The remaining terms are expressed as the following [13],

$$\int_{\tau^-}^{\tau^+} \widehat{M} \ddot{\vec{\mu}} dt = \widehat{M} \Delta \dot{\vec{\mu}} \quad (3.4)$$

$$\int_{\tau^-}^{\tau^+} \widehat{B}^T \vec{\lambda} dt = \widehat{B}^T \vec{\Lambda} \quad (3.5)$$

$$\int_{\tau^-}^{\tau^+} \vec{F}^p dt = \vec{L}^T H \quad (3.6)$$

where

$\dot{\vec{\mu}}$ is $(m + 2) \times 1$ velocity vector containing velocity expressions of both manipulator joint variables and the colliding body

$\vec{\Lambda}$: vector of impulses of constraint reaction forces.

$\vec{L}^T H$: vector of generalized impactive impulses where H is impulse of impact force

\vec{L} can be expressed as [13],

$$\vec{L} = \vec{z}^T (\widehat{L}^s - \widehat{L}^r) \quad (3.7)$$

where

\vec{z}^T is the transpose of the unit vector of normal direction of impact

\widehat{L}^r is the velocity influence coefficient matrix of the colliding body

\hat{L}^s is the velocity influence coefficient matrix of the manipulator

Hence Equation (3.2) and Equation (3.3) yields two equations respectively,

$$\hat{M}\Delta\dot{\vec{\mu}} - \hat{B}^T\vec{\Lambda} + \vec{L}^T H = 0 \quad (3.8)$$

$$\hat{F}^r\Delta\dot{\vec{\phi}} = 0 \quad (3.9)$$

As it is mentioned in Section 3.1, it is assumed that positions do not change during impact. Thus, the constraint equations in velocity level can be expressed as,

$$\sum_{k=1}^{m-n} B_{ki}\delta\dot{\theta}_i(\tau^+) - \sum_{k=1}^{m-n} B_{ki}\delta\dot{\theta}_i(\tau^-) = 0 \quad i = 1, \dots, m \quad (3.10)$$

Equation 3.10 can be written in an implicit form,

$$\hat{B}\Delta\dot{\vec{\mu}} = 0 \quad (3.11)$$

Classic impact theory implies that, there is a relationship between the relative velocities of colliding bodies before and after collision [13] which is,

$$\vec{z} \cdot [\hat{v}_{p1}^r(\tau^+) - \hat{v}_{p1}^s(\tau^+)] = -e\vec{z} \cdot [\hat{v}_{p1}^r(\tau^-) - \hat{v}_{p1}^s(\tau^-)] \quad (3.12)$$

where

\vec{z} is the unit vector of normal direction of impact

\hat{v}_{p1}^r is the velocity vector of the colliding body

\hat{v}_{p1}^s is the velocity vector of the manipulator

e is the coefficient of restitution

Equation (3.12) can be written in terms of velocity influence coefficient matrices as the following,

$$\vec{L}\Delta\dot{\vec{\mu}} = (e + 1)\vec{L}\dot{\vec{\mu}} \quad (3.13)$$

Therefore according to Equation 3.8, Equation 3.9 and Equation 3.13, system impulse-momentum equations can be written implicitly,

$$\begin{bmatrix} \hat{M} & -\hat{B}^T & \vec{L}^T \\ -\hat{B} & 0 & 0 \\ \vec{L} & 0 & 0 \end{bmatrix} \begin{bmatrix} \Delta \dot{\vec{\mu}} \\ \vec{\lambda} \\ H \end{bmatrix} = \begin{bmatrix} 0 \\ 0 \\ \alpha \end{bmatrix} \quad (3.14)$$

where

$$\alpha = (e + 1)\vec{L}\dot{\vec{\mu}} \quad (3.15)$$

CHAPTER 4

MODELLING AND CONTROL OF A 3-RPR FLEXIBLE JOINT PARALLEL MANIPULATOR SUBJECT TO AN IMPACT

4.1 Introduction

Planar, spherical and spatial manipulators are the three major types of parallel manipulators due to their motion characteristics and there are several possible limbs configurations in the manipulator construction by using either revolute or prismatic joints [1]. In this study, a system including a 3-RPR planar parallel manipulator is examined in order to analyze the effect of impact on a parallel manipulator having flexible-joint actuation and go through the control model. This manipulator has three legs with two revolute joints and one prismatic joint in each leg. Actuators are located at points A, B and C shown in Figure 2 which are all ground bases. All of the assumptions about flexible joints and impact characteristics, which are mentioned before in Chapter 2 and Chapter 3 respectively, are also valid for this case.

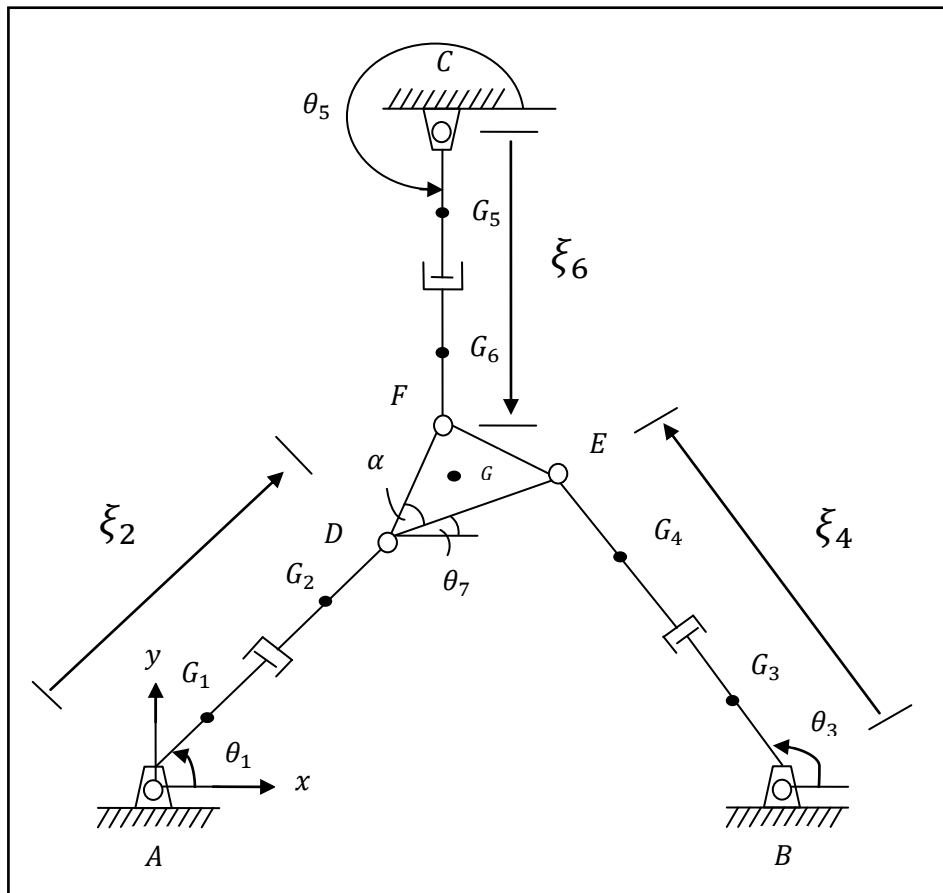

Figure 2 A 3-RPR Planar Parallel Manipulator

In order to write the generalized coordinates vector, both manipulator variables and actuator variables are needed to be defined. For this case, joint variables are $\theta_1, \theta_3, \theta_5, \theta_7, \xi_2, \xi_4, \xi_6$ and actuator variables of flexible joints are ϕ_1, ϕ_3, ϕ_5 . The vector of manipulator variables, η , including both actuated and unactuated joint variables turn out to be,

$$\bar{\eta} = [\theta_1, \theta_3, \theta_5, \theta_7, \xi_2, \xi_4, \xi_6]^T \quad (4.1)$$

where η can be defined as,

$$\bar{\eta} = [\eta^a, \eta^u]^T \quad (4.2)$$

$\bar{\eta}^a$ represents the vector of actuated joint variables and $\bar{\eta}^u$ is the vector of unactuated joint variables and both vectors can be expressed respectively in the form,

$$\bar{\eta}^a = [\theta_1, \theta_3, \theta_5]^T \quad (4.3)$$

$$\bar{\eta}^u = [\theta_7, \xi_2, \xi_4, \xi_6]^T \quad (4.4)$$

The vector of actuator variables of flexible joints can be written as,

$$\bar{\phi} = [\phi_1, \phi_3, \phi_5]^T \quad (4.5)$$

To calculate the degree of freedom of the manipulator, the following formula is used [20],

$$M = \sum f_i - \sum \lambda + q - J_p \quad (4.6)$$

where

- M is the mobility of the system
- f_i is the mobility of the i-th joint
- λ is the subspace of loops
- q is the number of excessive links
- J_p is the number of passive joints

There are neither excessive links nor passive joints in the manipulator. Besides there are there loops shown in Figure 3, but only two of them are independent and joint mobility of each revolute and prismatic joint is one, so the degree of freedom of the manipulator is three.

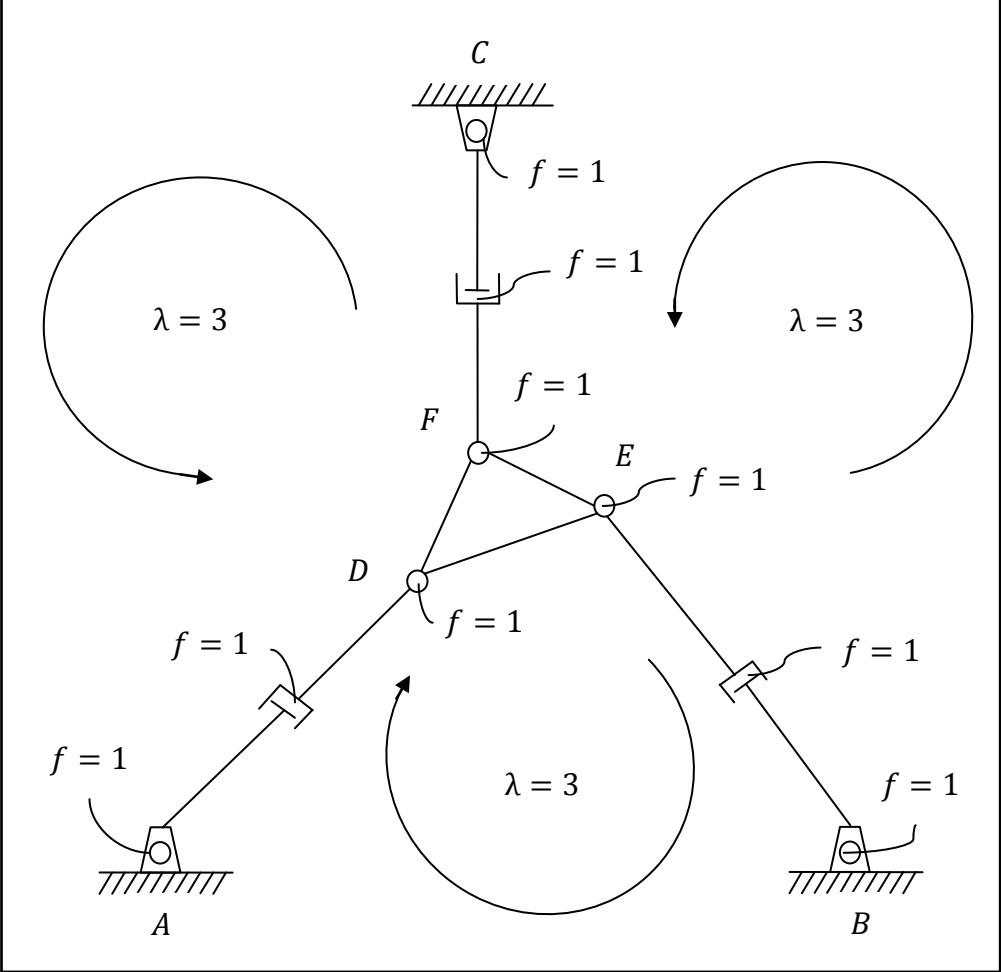

Figure 3 Loop Subspaces and Joint Degree of Freedoms

There are also additional degree of freedoms due to the presence of flexible joints. Each flexible joint contributes with an additional degree of freedom.

Since there are three flexible joint actuations, the total degree of freedom of the actuated system is six.

The number of joints to be removed is formulated as [20],

$$L = j - l \tag{4.7}$$

where

L is the number of joints to be removed

j is the number of joints

l is the number of moving links

According to Equation 4.7, two joints will be removed. Joint E and F are chosen to be removed.

4.2 Kinetic Energy of the System

In order to find the kinetic energy equations, both angular velocity vectors and translational velocity vectors are needed to be written. Each leg in the system is basically the combination of two links except the platform link (\overline{DFE}).

So for each leg, four equations will be written (two of them are angular velocity vectors and rest are translation velocity vectors).

First Leg $|AD|$:

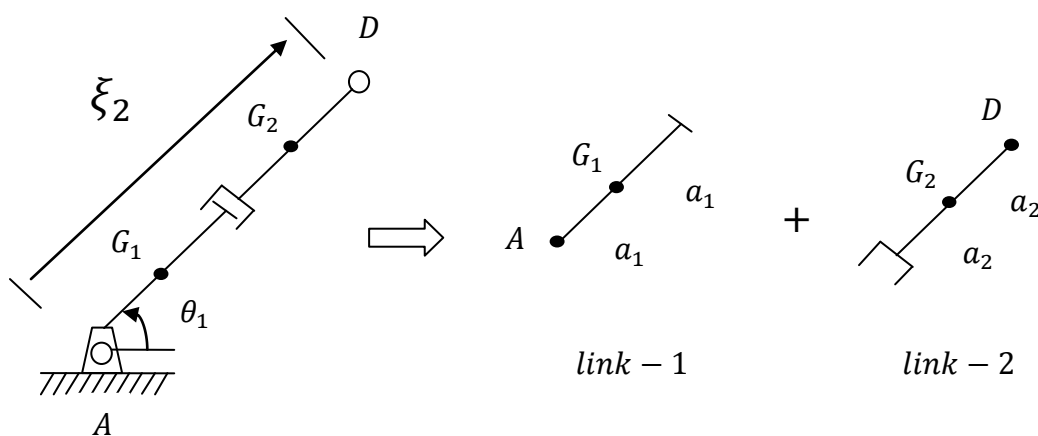

Figure 4 First Leg and Its Link Components

Position vector of the link-1:

$$\vec{r}_{G_1} = a_1 \cos(\theta_1) \vec{i} + a_1 \sin(\theta_1) \vec{j} \quad (4.8)$$

where a_1 is the distance between points of A and G_1 .

Velocity vector of the link-1:

$$\vec{V}_{G_1} = -a_1 \dot{\theta}_1 \sin(\theta_1) \vec{i} + a_1 \dot{\theta}_1 \cos(\theta_1) \vec{j} \quad (4.9)$$

Angular velocity of the link-1:

$$\vec{\omega}_1 = [0, 0, \dot{\theta}_1]^T \quad (4.10)$$

Position vector of the link-2:

$$\vec{r}_{G_2} = (\xi_2 - a_2) \cos(\theta_1) \vec{i} + (\xi_2 - a_2) \sin(\theta_1) \vec{j} \quad (4.11)$$

where a_2 is the distance between points of D and G_2 .

Velocity vector of the link-2:

$$\vec{V}_{G_2} = [\dot{\xi}_2 \cos(\theta_1) - (\xi_2 - a_2) \dot{\theta}_1 \sin(\theta_1)] \vec{i} + [\dot{\xi}_2 \sin(\theta_1) + (\xi_2 - a_2) \dot{\theta}_1 \cos(\theta_1)] \vec{j} \quad (4.12)$$

Angular velocity of the link-2:

$$\vec{\omega}_2 = [0, 0, \dot{\theta}_1]^T \quad (4.13)$$

Second Leg |BE|:

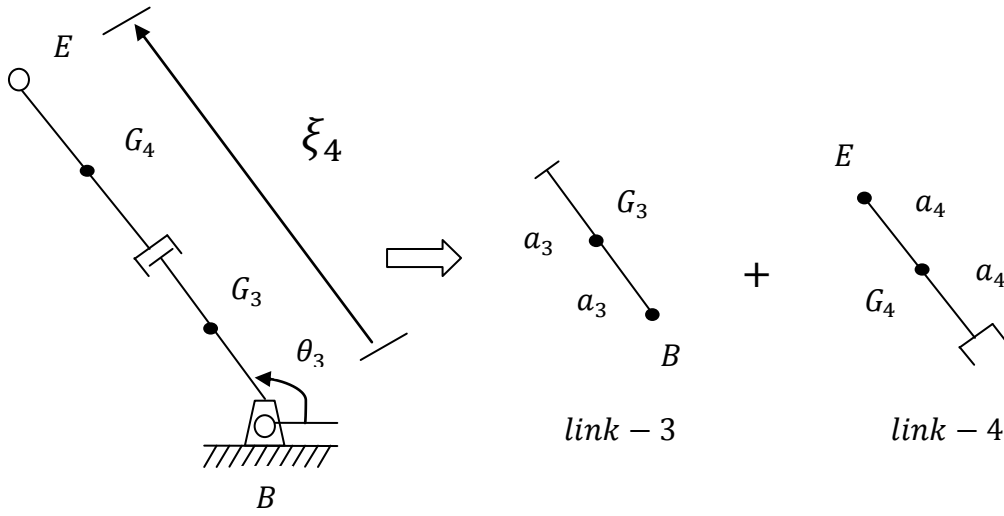

Figure 5 Second Leg and Its Link Components

Position vector of the link-3:

$$\vec{r}_{G3} = a_3 \cos(\theta_3) \vec{i} + a_3 \sin(\theta_3) \vec{j} \quad (4.14)$$

where a_3 is the distance between points of B and G_3 .

Velocity vector of the link-3:

$$\vec{V}_{G3} = -a_3 \dot{\theta}_3 \sin(\theta_3) \vec{i} + a_3 \dot{\theta}_3 \cos(\theta_3) \vec{j} \quad (4.15)$$

Angular velocity of the link-3:

$$\vec{\omega}_3 = [0, 0, \dot{\theta}_3]^T \quad (4.16)$$

Position vector of the link-4:

$$\vec{r}_{G4} = (\xi_4 - a_4) \cos(\theta_3) \vec{i} + (\xi_4 - a_4) \sin(\theta_3) \vec{j} \quad (4.17)$$

where a_4 is the distance between points of E and G_4 .

Velocity vector of the link-4:

$$\vec{V}_{G4} = [\dot{\xi}_4 \cos(\theta_3) - (\xi_4 - a_4)\dot{\theta}_3 \sin(\theta_3)]\vec{i} + [\dot{\xi}_4 \sin(\theta_3) + (\xi_4 - a_4)\dot{\theta}_3 \cos(\theta_3)]\vec{j} \quad (4.18)$$

Angular velocity of the link-4:

$$\vec{\omega}_4 = [0, 0, \dot{\theta}_3]^T \quad (4.19)$$

Third Leg |CF|:

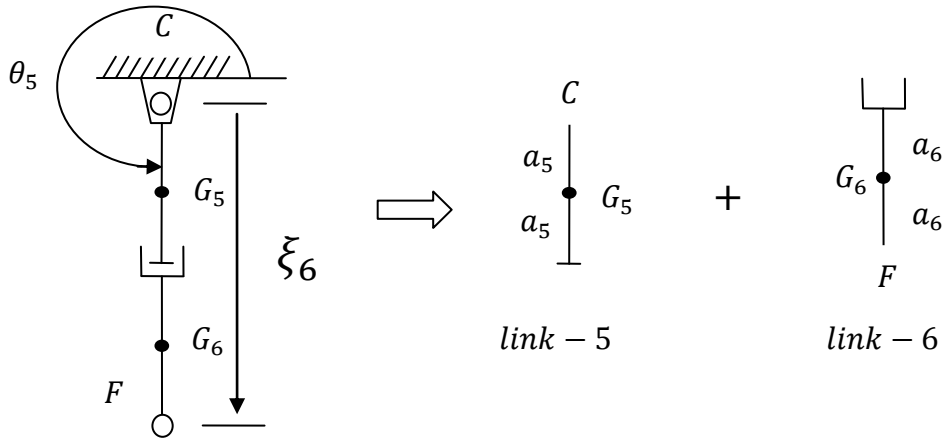

Figure 6 Third Leg and Its Link Components

Position vector of the link-5:

$$\vec{r}_{G5} = a_5 \cos(\theta_5) \vec{i} + a_5 \sin(\theta_5) \vec{j} \quad (4.20)$$

where a_5 is the distance between points of C and G_5 .

Velocity vector of the link-5:

$$\vec{V}_{G5} = -a_5 \dot{\theta}_5 \sin(\theta_5) \vec{i} + a_5 \dot{\theta}_5 \cos(\theta_5) \vec{j} \quad (4.21)$$

Angular velocity of the link-5:

$$\vec{\omega}_5 = [0, 0, \dot{\theta}_5]^T \quad (4.22)$$

Position vector of the link-6:

$$\vec{r}_{G_6} = (\xi_6 - a_6) \cos(\theta_5) \vec{i} + (\xi_6 - a_6) \sin(\theta_5) \vec{j} \quad (4.23)$$

where a_6 is the distance between points of F and G_6 .

Velocity vector of the link-6:

$$\vec{V}_{G_6} = [\dot{\xi}_6 \cos(\theta_5) - (\xi_6 - a_6) \dot{\theta}_5 \sin(\theta_5)] \vec{i} + [\dot{\xi}_6 \sin(\theta_5) + (\xi_6 - a_6) \dot{\theta}_5 \cos(\theta_5)] \vec{j} \quad (4.24)$$

Angular velocity of the link-6:

$$\vec{\omega}_6 = [0, 0, \dot{\theta}_5]^T \quad (4.25)$$

Link 7, \widehat{DFE} :

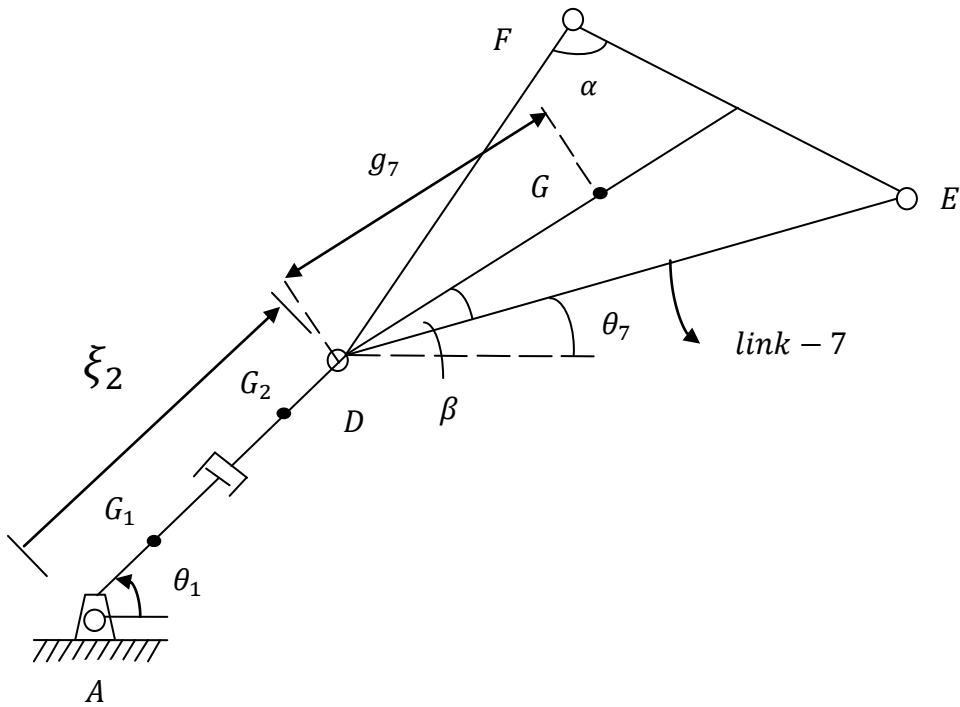

Figure 7 Link 7 and Its Link Components

Position vector of the link-7:

$$\vec{r}_{G7} = \xi_2 \cos(\theta_1) \vec{i} + \xi_2 \sin(\theta_1) \vec{j} + g_7 [\cos(\theta_7 + \beta) \vec{i} + \sin(\theta_7 + \beta) \vec{j}] \quad (4.26)$$

where g_7 is the distance between points of D and G.

Velocity vector of the link-7:

$$\vec{V}_{G7} = (\dot{\xi}_2 \cos(\theta_1) - \xi_2 \dot{\theta}_1 \sin(\theta_1)) \vec{i} + (\dot{\xi}_2 \sin(\theta_1) + \xi_2 \dot{\theta}_1 \cos(\theta_1)) \vec{j} + g_7 [-\dot{\theta}_7 \sin(\theta_7 + \beta) \vec{i} + \dot{\theta}_7 \cos(\theta_7 + \beta) \vec{j}] \quad (4.27)$$

Angular velocity of the link-7:

$$\vec{\omega}_7 = [0, 0, \dot{\theta}_7]^T \quad (4.28)$$

In addition to velocity vectors of a chain link, velocity vectors of an actuator is also needed to be derived since it contributes to the total kinetic energy of a link (see Section 2.5)

First Actuator (At Point A):

$$\text{Velocity vector of the first actuator:} \quad \vec{V}_1^A = \vec{0} \quad (4.29)$$

$$\text{Angular velocity of the first actuator:} \quad \vec{\omega}_1^A = [0, 0, r_1 \dot{\phi}_1]^T \quad (4.30)$$

Second Actuator (At Point B):

$$\text{Velocity vector of the second actuator:} \quad \vec{V}_2^A = \vec{0} \quad (4.31)$$

$$\text{Angular velocity of the second actuator:} \quad \vec{\omega}_2^A = [0, 0, r_3 \dot{\phi}_3]^T \quad (4.32)$$

Third Actuator (At Point C):

$$\text{Velocity vector of the third actuator: } \vec{V}_3^A = \vec{0} \quad (4.33)$$

$$\text{Angular velocity of the third actuator: } \vec{\omega}_3^A = [0, 0, r_5 \dot{\phi}_5]^T \quad (4.34)$$

Kinetic Energy of Link-1:

$$KE_{L1} = \frac{1}{2} [m_1 a_1^2 + I_{1zz}] \dot{\theta}_1^2 \quad (4.35)$$

where I_{1zz} is the inertia and m_1 is the mass of the first link.

Kinetic Energy of Link-2:

$$KE_{L2} = \frac{1}{2} m_2 [\dot{\xi}_2^2 + (\xi_2 - a_2)^2 \dot{\theta}_1^2] + \frac{1}{2} I_{2zz} \dot{\theta}_1^2 \quad (4.36)$$

where I_{2zz} is the inertia and m_2 is the mass of the second link.

Kinetic Energy of Link-3:

$$KE_{L3} = \frac{1}{2} [m_3 a_3^2 + I_{3zz}] \dot{\theta}_3^2 \quad (4.37)$$

where I_{3zz} is the inertia and m_3 is the mass of the third link.

Kinetic Energy of Link-4:

$$KE_{L4} = \frac{1}{2} m_4 [\dot{\xi}_4^2 + (\xi_4 - a_4)^2 \dot{\theta}_3^2] + \frac{1}{2} I_{4zz} \dot{\theta}_3^2 \quad (4.38)$$

where I_{4zz} is the inertia and m_4 is the mass of the fourth link.

Kinetic Energy of Link-5:

$$KE_{L5} = \frac{1}{2}[m_5 a_5^2 + I_{5zz}] \dot{\theta}_5^2 \quad (4.39)$$

where I_{5zz} is the inertia and m_5 is the mass of the fifth link.

Kinetic Energy of Link-6:

$$KE_{L6} = \frac{1}{2} m_6 [\dot{\xi}_6^2 + (\xi_6 - a_6)^2 \dot{\theta}_5^2] + \frac{1}{2} I_{6zz} \dot{\theta}_5^2 \quad (4.40)$$

where I_{6zz} is the inertia and m_6 is the mass of the sixth link.

Kinetic Energy of Link-7:

$$KE_{L7} = \frac{1}{2} m_7 [\dot{\xi}_2^2 + \dot{\xi}_2^2 \dot{\theta}_1^2 + g_7 \dot{\theta}_7^2 + 2(\xi_2 \dot{\theta}_1 g_7 \dot{\theta}_7 \cos(\theta_1 - \theta_7 - \beta) + \dot{\xi}_2 g_7 \dot{\theta}_7 \sin(\theta_1 - \theta_7 - \beta))] + \frac{1}{2} I_{7zz} \dot{\theta}_7^2 \quad (4.41)$$

where I_{7zz} is the inertia and m_7 is the mass of the seventh link.

Kinetic Energy of Actuator-1:

$$KE_{A1} = \frac{1}{2} [r_1^2 I_{1zz}^r] \dot{\phi}_1^2 \quad (4.42)$$

where I_{1zz}^r is the rotor inertia reduced to gear output shaft and r_1 is the gear ratio.

Kinetic Energy of Actuator-2:

$$KE_{A2} = \frac{1}{2} [r_3^2 I_{3zz}^r] \dot{\phi}_3^2 \quad (4.43)$$

where I_{3zz}^r is the rotor inertia reduced to gear output shaft and r_3 is the gear ratio.

Kinetic Energy of Actuator-3:

$$KE_{A3} = \frac{1}{2} [r_5^2 I_{5zz}^r] \dot{\phi}_5^2 \quad (4.44)$$

where I_{5zz}^r is the rotor inertia reduced to gear output shaft and r_5 is the gear ratio.

Equation 2.14 implies that the total kinetic energy of the system is the sum of the total kinetic energy of the actuators and the total kinetic energy of the links which results in,

$$\begin{aligned} KE_{Total} = & \frac{1}{2} [r_1^2 I_{1zz}^r] \dot{\phi}_1^2 + \frac{1}{2} [r_3^2 I_{3zz}^r] \dot{\phi}_3^2 + \frac{1}{2} [r_5^2 I_{5zz}^r] \dot{\phi}_5^2 + \frac{1}{2} [m_1 a_1^2 + I_{1zz}] \dot{\theta}_1^2 \\ & + \frac{1}{2} [m_3 a_3^2 + I_{3zz}] \dot{\theta}_3^2 + \frac{1}{2} [m_5 a_5^2 + I_{5zz}] \dot{\theta}_5^2 + \frac{1}{2} m_2 [\dot{\xi}_2^2 + (\xi_2 - a_2)^2 \dot{\theta}_1^2] \\ & + \frac{1}{2} I_{2zz} \dot{\theta}_1^2 + \frac{1}{2} m_4 [\dot{\xi}_4^2 + (\xi_4 - a_4)^2 \dot{\theta}_3^2] + \frac{1}{2} I_{4zz} \dot{\theta}_3^2 \\ & + \frac{1}{2} m_6 [\dot{\xi}_6^2 + (\xi_6 - a_6)^2 \dot{\theta}_5^2] + \frac{1}{2} I_{6zz} \dot{\theta}_5^2 \\ & + \frac{1}{2} m_7 [\dot{\xi}_2^2 + \dot{\xi}_2^2 \dot{\theta}_1^2 + g_7 \dot{\theta}_7^2 + 2(\xi_2 \dot{\theta}_1 g_7 \dot{\theta}_7 \cos(\theta_1 - \theta_7 - \beta) + \dot{\xi}_2 g_7 \dot{\theta}_7 \sin(\theta_1 \\ & - \theta_7 - \beta))] + \frac{1}{2} I_{7zz} \dot{\theta}_7^2 \end{aligned} \quad (4.45)$$

4.3 Potential Energy of the System

The same technique, disconnecting three joints and having four kinematic chains, is used to find potential energy of each link and actuator.

$$PE_{L1} = m_1 g a_1 \sin(\theta_1) \quad (4.46)$$

$$PE_{L2} = m_2 g (\xi_2 - a_2) \sin(\theta_1) \quad (4.47)$$

$$PE_{L3} = m_3 g a_3 \sin(\theta_3) \quad (4.48)$$

$$PE_{L4} = m_4 g (\xi_4 - a_4) \sin(\theta_3) \quad (4.49)$$

$$PE_{L5} = m_5 g a_5 \sin(\theta_5) \quad (4.50)$$

$$PE_{L6} = m_6 g (\xi_6 - a_6) \sin(\theta_5) \quad (4.51)$$

$$PE_{L7} = m_7 g [\xi_2 \sin(\theta_1) + g_7 \sin(\theta_7 + \beta)] \quad (4.52)$$

$$PE_{A1} = \frac{1}{2} K_1 (\phi_1 - \theta_1)^2 \quad (4.53)$$

$$PE_{A2} = \frac{1}{2}K_3(\phi_3 - \theta_3)^2 \quad (4.54)$$

$$PE_{A3} = \frac{1}{2}K_5(\phi_5 - \theta_5)^2 \quad (4.55)$$

It is clear that the total potential energy of the system is the combination of all potential energies of actuators and links.

$$\begin{aligned} PE_{Total} = & m_1ga_1 \sin(\theta_1) + m_3ga_3 \sin(\theta_3) + m_5ga_5 \sin(\theta_5) + m_2g(\xi_2 - a_2) \sin(\theta_1) + \\ & m_4g(\xi_4 - a_4) \sin(\theta_3) + m_6g(\xi_6 - a_6) \sin(\theta_5) + m_7g[\xi_2 \sin(\theta_1) + g_7 \sin(\theta_7 + \beta)] + \\ & \frac{1}{2}K_1(\phi_1 - \theta_1)^2 + \frac{1}{2}K_3(\phi_3 - \theta_3)^2 + \frac{1}{2}K_5(\phi_5 - \theta_5)^2 \end{aligned} \quad (4.56)$$

4.4 Dissipation Function of the System

According to Equation (2.18), dissipation function of the actuated joints, is the followings,

$$D^a = \frac{1}{2}D_1(\dot{\theta}_1 - \dot{\phi}_1)^2 + \frac{1}{2}D_3(\dot{\theta}_3 - \dot{\phi}_3)^2 + \frac{1}{2}D_5(\dot{\theta}_5 - \dot{\phi}_5)^2 \quad (4.57)$$

Since there are no other damping sources in the system, the total dissipation function is,

$$D = \frac{1}{2}D_1(\dot{\theta}_1 - \dot{\phi}_1)^2 + \frac{1}{2}D_3(\dot{\theta}_3 - \dot{\phi}_3)^2 + \frac{1}{2}D_5(\dot{\theta}_5 - \dot{\phi}_5)^2 \quad (4.58)$$

In order to proceed to the next step, which is deriving the system equations, Lagrange components of total kinetic energy, total potential energy and total dissipation function is needed to be written likewise in Section 2.4.

4.5 Lagrange Components of Expressions

$$\begin{aligned} \frac{\partial K}{\partial \dot{\theta}_1} = & (m_1a_1^2 + I_{1zz})\dot{\theta}_1 + m_2(\xi_2 - a_2)^2\dot{\theta}_1 + I_{2zz}\dot{\theta}_1 + m_7\xi_2^2\dot{\theta}_1 \\ & + m_7\xi_2g_7\dot{\theta}_7 \cos(\theta_1 - \theta_7 - \beta) \end{aligned} \quad (4.61)$$

$$\begin{aligned} \frac{d}{dt} \left(\frac{\partial K}{\partial \dot{\theta}_1} \right) &= (m_1 a_1^2 + I_{1zz}) \ddot{\theta}_1 + m_2 (\xi_2 - a_2)^2 \ddot{\theta}_1 + 2m_2 (\xi_2 - a_2) \dot{\xi}_2 \dot{\theta}_1 + I_{2zz} \ddot{\theta}_1 + m_7 \xi_2^2 \ddot{\theta}_1 \\ &\quad + 2m_7 \dot{\xi}_2 \xi_2 \dot{\theta}_1 + m_7 \dot{\xi}_2 g_7 \dot{\theta}_7 \cos(\theta_1 - \theta_7 - \beta) + m_7 \xi_2 g_7 \ddot{\theta}_7 \cos(\theta_1 - \theta_7 - \beta) \\ &\quad - m_7 \xi_2 g_7 \dot{\theta}_7 \sin(\theta_1 - \theta_7 - \beta) (\dot{\theta}_1 - \dot{\theta}_7) \end{aligned} \quad (4.62)$$

$$\frac{\partial K}{\partial \dot{\theta}_3} = (m_3 a_3^2 + I_{3zz}) \dot{\theta}_3 + m_4 (\xi_4 - a_4)^2 \dot{\theta}_3 + I_{4zz} \dot{\theta}_3 \quad (4.63)$$

$$\frac{d}{dt} \left(\frac{\partial K}{\partial \dot{\theta}_3} \right) = (m_3 a_3^2 + I_{3zz}) \ddot{\theta}_3 + m_4 (\xi_4 - a_4)^2 \ddot{\theta}_3 + 2m_4 (\xi_4 - a_4) \dot{\xi}_4 \dot{\theta}_3 + I_{4zz} \ddot{\theta}_3 \quad (4.64)$$

$$\frac{\partial K}{\partial \dot{\theta}_5} = (m_5 a_5^2 + I_{5zz}) \dot{\theta}_5 + m_6 (\xi_6 - a_6)^2 \dot{\theta}_5 + I_{6zz} \dot{\theta}_5 \quad (4.65)$$

$$\frac{d}{dt} \left(\frac{\partial K}{\partial \dot{\theta}_5} \right) = (m_5 a_5^2 + I_{5zz}) \ddot{\theta}_5 + m_6 (\xi_6 - a_6)^2 \ddot{\theta}_5 + 2m_6 (\xi_6 - a_6) \dot{\xi}_6 \dot{\theta}_5 + I_{6zz} \ddot{\theta}_5 \quad (4.66)$$

$$\frac{\partial K}{\partial \dot{\theta}_7} = m_7 g_7^2 \dot{\theta}_7 + m_7 \xi_2 \dot{\theta}_1 g_7 \cos(\theta_1 - \theta_7 - \beta) + m_7 \dot{\xi}_2 g_7 \sin(\theta_1 - \theta_7 - \beta) + I_{7zz} \dot{\theta}_7 \quad (4.67)$$

$$\begin{aligned} \frac{d}{dt} \left(\frac{\partial K}{\partial \dot{\theta}_7} \right) &= m_7 g_7^2 \ddot{\theta}_7 + m_7 \dot{\xi}_2 \dot{\theta}_1 g_7 \cos(\theta_1 - \theta_7 - \beta) + m_7 \xi_2 g_7 \ddot{\theta}_1 \cos(\theta_1 - \theta_7 - \beta) \\ &\quad - m_7 \xi_2 g_7 \dot{\theta}_1 \sin(\theta_1 - \theta_7 - \beta) (\dot{\theta}_1 - \dot{\theta}_7) \\ &\quad + m_7 \dot{\xi}_2 g_7 \sin(\theta_1 - \theta_7 - \beta) + m_7 \xi_2 g_7 \cos(\theta_1 - \theta_7 - \beta) (\dot{\theta}_1 - \dot{\theta}_7) + I_{7zz} \ddot{\theta}_7 \end{aligned} \quad (4.68)$$

$$\frac{\partial K}{\partial \dot{\xi}_2} = m_2 \dot{\xi}_2 + m_7 \dot{\xi}_2 + m_7 g_7 \dot{\theta}_7 \sin(\theta_1 - \theta_7 - \beta) \quad (4.69)$$

$$\frac{d}{dt} \left(\frac{\partial K}{\partial \dot{\xi}_2} \right) = m_2 \ddot{\xi}_2 + m_7 \ddot{\xi}_2 + m_7 g_7 \ddot{\theta}_7 \sin(\theta_1 - \theta_7 - \beta) + m_7 \dot{\theta}_7 g_7 \cos(\theta_1 - \theta_7 - \beta) (\dot{\theta}_1 - \dot{\theta}_7) \quad (4.70)$$

$$\frac{\partial K}{\partial \dot{\xi}_4} = m_4 \dot{\xi}_4 \quad (4.71)$$

$$\frac{d}{dt} \left(\frac{\partial K}{\partial \dot{\xi}_4} \right) = m_4 \ddot{\xi}_4 \quad (4.72)$$

$$\frac{\partial K}{\partial \dot{\xi}_6} = m_6 \dot{\xi}_6 \quad (4.73)$$

$$\frac{d}{dt} \left(\frac{\partial K}{\partial \dot{\xi}_6} \right) = m_6 \ddot{\xi}_6 \quad (4.74)$$

$$\frac{\partial K}{\partial \dot{\phi}_1} = r_1^2 I_{1zz}^r \dot{\phi}_1 \quad (4.75)$$

$$\frac{d}{dt} \left(\frac{\partial K}{\partial \dot{\phi}_1} \right) = r_1^2 I_{1zz}^r \ddot{\phi}_1 \quad (4.76)$$

$$\frac{\partial K}{\partial \dot{\phi}_3} = r_3^2 I_{3zz}^r \dot{\phi}_3 \quad (4.77)$$

$$\frac{d}{dt} \left(\frac{\partial K}{\partial \dot{\phi}_3} \right) = r_3^2 I_{3zz}^r \ddot{\phi}_3 \quad (4.78)$$

$$\frac{\partial K}{\partial \dot{\phi}_5} = r_5^2 I_{5zz}^r \dot{\phi}_5 \quad (4.79)$$

$$\frac{d}{dt} \left(\frac{\partial K}{\partial \dot{\phi}_5} \right) = r_5^2 I_{5zz}^r \ddot{\phi}_5 \quad (4.80)$$

$$\frac{\partial K}{\partial \theta_1} = -m_7 \xi_2 \dot{\theta}_1 g_7 \dot{\theta}_7 \sin(\theta_1 - \theta_7 - \beta) + m_7 \xi_2 g_7 \dot{\theta}_7 \cos(\theta_1 - \theta_7 - \beta) \quad (4.81)$$

$$\frac{\partial K}{\partial \theta_3} = 0 \quad (4.82)$$

$$\frac{\partial K}{\partial \theta_5} = 0 \quad (4.83)$$

$$\frac{\partial K}{\partial \theta_7} = -m_7 \xi_2 \dot{\theta}_1 g_7 \dot{\theta}_7 \sin(\theta_1 - \theta_7 - \beta) + m_7 \xi_2 g_7 \dot{\theta}_7 \cos(\theta_1 - \theta_7 - \beta) \quad (4.84)$$

$$\frac{\partial K}{\partial \xi_2} = m_2 (\xi_2 - a_2) \dot{\theta}_1^2 + m_7 \xi_2 \dot{\theta}_1^2 + m_7 \dot{\theta}_1 g_7 \dot{\theta}_7 \cos(\theta_1 - \theta_7 - \beta) \quad (4.85)$$

$$\frac{\partial K}{\partial \xi_4} = m_4 (\xi_4 - a_4) \dot{\theta}_3^2 \quad (4.86)$$

$$\frac{\partial K}{\partial \xi_6} = m_6 (\xi_6 - a_6) \dot{\theta}_5^2 \quad (4.87)$$

$$\frac{\partial K}{\partial \phi_1} = 0 \quad (4.88)$$

$$\frac{\partial K}{\partial \phi_3} = 0 \quad (4.89)$$

$$\frac{\partial K}{\partial \phi_5} = 0 \quad (4.90)$$

$$\frac{\partial U}{\partial \theta_1} = m_1 g a_1 \cos(\theta_1) + m_2 g (\xi_2 - a_2) \cos(\theta_1) + m_7 g \xi_2 \cos(\theta_1) - K_1 (\phi_1 - \theta_1) \quad (4.91)$$

$$\frac{\partial U}{\partial \theta_3} = m_3 g a_3 \cos(\theta_3) + m_4 g (\xi_4 - a_4) \cos(\theta_3) - K_2 (\phi_3 - \theta_3) \quad (4.92)$$

$$\frac{\partial U}{\partial \theta_5} = m_5 g a_5 \cos(\theta_5) + m_6 g (\xi_6 - a_6) \cos(\theta_5) - K_3 (\phi_5 - \theta_5) \quad (4.93)$$

$$\frac{\partial U}{\partial \theta_7} = m_7 g a_7 \cos(\theta_7 + \beta) \quad (4.94)$$

$$\frac{\partial U}{\partial \xi_2} = m_2 g \sin(\theta_1) + m_7 g \sin(\theta_1) \quad (4.95)$$

$$\frac{\partial U}{\partial \xi_4} = m_4 g \sin(\theta_3) \quad (4.96)$$

$$\frac{\partial U}{\partial \xi_6} = m_6 g \sin(\theta_5) \quad (4.97)$$

$$\frac{\partial U}{\partial \phi_1} = K_1(\phi_1 - \theta_1) \quad (4.98)$$

$$\frac{\partial U}{\partial \phi_3} = K_3(\phi_3 - \theta_3) \quad (4.99)$$

$$\frac{\partial U}{\partial \phi_5} = K_5(\phi_5 - \theta_5) \quad (4.100)$$

$$\frac{\partial D}{\partial \dot{\theta}_1} = D_1(\dot{\theta}_1 - \dot{\phi}_1) \quad (4.101)$$

$$\frac{\partial D}{\partial \dot{\theta}_3} = D_3(\dot{\theta}_3 - \dot{\phi}_3) \quad (4.102)$$

$$\frac{\partial D}{\partial \dot{\theta}_5} = D_5(\dot{\theta}_5 - \dot{\phi}_5) \quad (4.103)$$

$$\frac{\partial D}{\partial \dot{\theta}_7} = 0 \quad (4.104)$$

$$\frac{\partial D}{\partial \dot{\xi}_2} = 0 \quad (4.105)$$

$$\frac{\partial D}{\partial \dot{\xi}_4} = 0 \quad (4.106)$$

$$\frac{\partial D}{\partial \dot{\xi}_6} = 0 \quad (4.107)$$

$$\frac{\partial D}{\partial \dot{\phi}_1} = -D_1(\dot{\theta}_1 - \dot{\phi}_1) \quad (4.108)$$

$$\frac{\partial D}{\partial \dot{\phi}_3} = -D_3(\dot{\theta}_3 - \dot{\phi}_3) \quad (4.109)$$

$$\frac{\partial D}{\partial \dot{\phi}_5} = -D_5(\dot{\theta}_5 - \dot{\phi}_5) \quad (4.110)$$

4.6 Constraint Equations

As it is mentioned in Section 4.1, two joints (Joint E and Joint F) are chosen to be disconnected so that four constraint equations are needed to be written.

Distances between the grounds and lengths of the each link are shown in Figure 8.

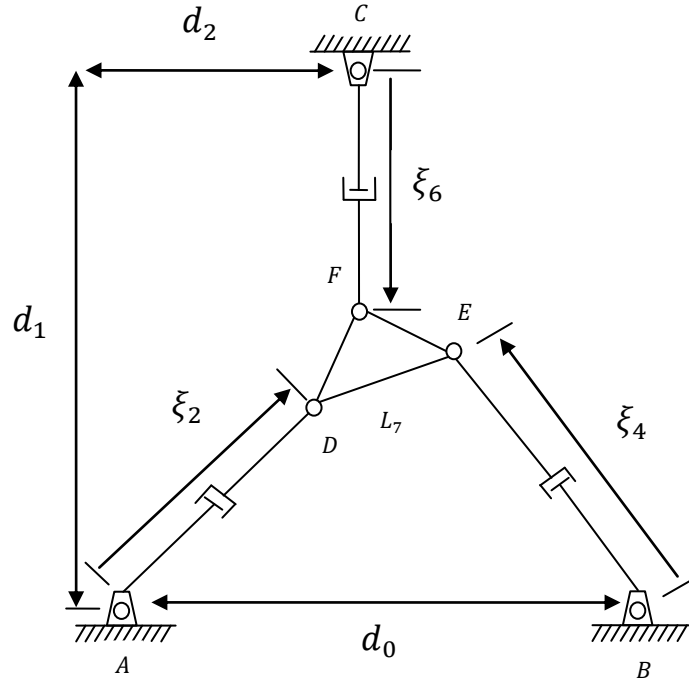

Figure 8 Link Lengths and Dimensions

$$\overline{AD} + \overline{DE} = \overline{AB} + \overline{BE} \quad (4.111)$$

Position level constraint equations of the first loop are the followings,

$$\xi_2 \cos(\theta_1) + L_7 \cos(\theta_7) - \xi_4 \cos(\theta_3) - d_0 = 0 \quad (4.112)$$

$$\xi_2 \sin(\theta_1) + L_7 \sin(\theta_7) - \xi_4 \sin(\theta_3) = 0 \quad (4.113)$$

Velocity level constraint equations of the first loop are the followings,

$$\dot{\xi}_2 \cos(\theta_1) - \xi_2 \sin(\theta_1) \dot{\theta}_1 - L_7 \sin(\theta_7) \dot{\theta}_7 - \dot{\xi}_4 \cos(\theta_3) + \xi_4 \sin(\theta_3) \dot{\theta}_3 = 0 \quad (4.114)$$

$$\dot{\xi}_2 \sin(\theta_1) + \xi_2 \cos(\theta_1) \dot{\theta}_1 + L_7 \cos(\theta_7) \dot{\theta}_7 - \dot{\xi}_4 \sin(\theta_3) - \xi_4 \cos(\theta_3) \dot{\theta}_3 = 0 \quad (4.115)$$

Position level constraint equations of the second loop are the followings,

$$\overline{AD} + \overline{DF} = \overline{AC} + \overline{CF} \quad (4.116)$$

$$\xi_2 e^{i\theta_1} + L_7 e^{i(\theta_7 + \alpha)} = d_1 i + d_2 + \xi_6 e^{i\theta_5} \quad (4.117)$$

$$\xi_2 \cos(\theta_1) + L_7 \cos(\theta_7 + \alpha) - d_2 - \xi_6 \cos(\theta_5) = 0 \quad (4.118)$$

$$\xi_2 \sin(\theta_1) + L_7 \sin(\theta_7 + \alpha) - d_1 - \xi_6 \sin(\theta_5) = 0 \quad (4.119)$$

Velocity level constraint equations of the second loop are the followings,

$$\dot{\xi}_2 \cos(\theta_1) - \xi_2 \sin(\theta_1) \dot{\theta}_1 - L_7 \sin(\theta_7 + \alpha) \dot{\theta}_7 - \dot{\xi}_6 \cos(\theta_5) + \xi_6 \sin(\theta_5) \dot{\theta}_5 = 0 \quad (4.120)$$

$$\dot{\xi}_2 \sin(\theta_1) + \xi_2 \cos(\theta_1) \dot{\theta}_1 + L_7 \cos(\theta_7 + \alpha) \dot{\theta}_7 - \dot{\xi}_6 \sin(\theta_5) - \xi_6 \cos(\theta_5) \dot{\theta}_5 = 0 \quad (4.121)$$

The four velocity level constraint equations derived above can be written implicitly as,

$$B_{11} \dot{\theta}_1 + B_{12} \dot{\theta}_3 + B_{13} \dot{\theta}_5 + B_{14} \dot{\theta}_7 + B_{15} \dot{\xi}_2 + B_{16} \dot{\xi}_4 + B_{17} \dot{\xi}_6 = 0 \quad (4.122)$$

$$B_{21} \dot{\theta}_1 + B_{22} \dot{\theta}_3 + B_{23} \dot{\theta}_5 + B_{24} \dot{\theta}_7 + B_{25} \dot{\xi}_2 + B_{26} \dot{\xi}_4 + B_{27} \dot{\xi}_6 = 0 \quad (4.123)$$

$$B_{31} \dot{\theta}_1 + B_{32} \dot{\theta}_3 + B_{33} \dot{\theta}_5 + B_{34} \dot{\theta}_7 + B_{35} \dot{\xi}_2 + B_{36} \dot{\xi}_4 + B_{37} \dot{\xi}_6 = 0 \quad (4.124)$$

$$B_{41} \dot{\theta}_1 + B_{42} \dot{\theta}_3 + B_{43} \dot{\theta}_5 + B_{44} \dot{\theta}_7 + B_{45} \dot{\xi}_2 + B_{46} \dot{\xi}_4 + B_{47} \dot{\xi}_6 = 0 \quad (4.125)$$

where

$$B_{11} = -\xi_2 \sin(\theta_1) \quad (4.126)$$

$$B_{12} = \xi_4 \sin(\theta_3) \quad (4.127)$$

$$B_{13} = 0 \quad (4.128)$$

$$B_{14} = -L_7 \sin(\theta_7) \quad (4.129)$$

$$B_{15} = \cos(\theta_1) \quad (4.130)$$

$$B_{16} = -\cos(\theta_3) \quad (4.131)$$

$$B_{17} = 0 \quad (4.132)$$

$$B_{21} = \xi_2 \cos(\theta_1) \quad (4.133)$$

$$B_{22} = -\xi_4 \cos(\theta_3) \quad (4.134)$$

$$B_{23} = 0 \quad (4.135)$$

$$B_{24} = L_7 \cos(\theta_7) \quad (4.136)$$

$$B_{25} = \sin(\theta_1) \quad (4.137)$$

$$B_{26} = -\sin(\theta_3) \quad (4.138)$$

$$B_{27} = 0 \quad (4.139)$$

$$B_{31} = -\xi_2 \sin(\theta_1) \quad (4.140)$$

$$B_{32} = 0 \quad (4.141)$$

$$B_{33} = \xi_6 \sin(\theta_5) \quad (4.142)$$

$$B_{34} = -L_7 \sin(\theta_7 + \alpha) \quad (4.143)$$

$$B_{35} = \cos(\theta_1) \quad (4.144)$$

$$B_{36} = 0 \quad (4.145)$$

$$B_{37} = -\cos(\theta_5) \quad (4.146)$$

$$B_{41} = \xi_2 \cos(\theta_1) \quad (4.147)$$

$$B_{42} = 0 \quad (4.148)$$

$$B_{43} = -\xi_6 \sin(\theta_5) \quad (4.149)$$

$$B_{44} = L_7 \cos(\theta_7 + \alpha) \quad (4.150)$$

$$B_{45} = \sin(\theta_1) \quad (4.151)$$

$$B_{46} = 0 \quad (4.152)$$

$$B_{47} = -\sin(\theta_5) \quad (4.153)$$

Expressions given above can be written in the matrix form as,

$$\hat{B}^r = \begin{bmatrix} B_{11} & B_{12} & B_{13} & B_{14} & B_{15} & B_{16} & B_{17} \\ B_{21} & B_{22} & B_{23} & B_{24} & B_{25} & B_{26} & B_{27} \\ B_{31} & B_{32} & B_{33} & B_{34} & B_{35} & B_{36} & B_{37} \\ B_{41} & B_{42} & B_{43} & B_{44} & B_{45} & B_{46} & B_{47} \end{bmatrix} \quad (4.154)$$

Equation (4.154) is subdivided into two matrices as,

$$\hat{B}^a = \begin{bmatrix} B_{11} & B_{12} & B_{13} \\ B_{21} & B_{22} & B_{23} \\ B_{31} & B_{32} & B_{33} \\ B_{41} & B_{42} & B_{43} \end{bmatrix} \quad (4.155)$$

where \hat{B}^a matrix consists of expressions corresponding to actuated joint variables.

$$\hat{B}^u = \begin{bmatrix} B_{14} & B_{15} & B_{16} & B_{17} \\ B_{24} & B_{25} & B_{26} & B_{27} \\ B_{34} & B_{35} & B_{36} & B_{37} \\ B_{44} & B_{45} & B_{46} & B_{47} \end{bmatrix} \quad (4.156)$$

where \hat{B}^u matrix consists of expressions corresponding to unactuated joint variables.

Equation (2.23) and Equation (2.24) implies that non-potentialized forces are,

$$f_1' = \vec{0} \quad (4.157)$$

$$f_2' = \vec{T} \quad (4.158)$$

4.7 System Equations of Motion and System Impulse-Momentum Equations

According to Equation (2.30) the system equations of motion corresponding to the first set of generalized coordinates is the following,

$$\widehat{M}^r \ddot{\vec{q}} + \vec{Q} + \vec{D} + \vec{K} - \widehat{B}^{rT} \vec{\lambda} = 0 \quad (4.159)$$

where

$$\widehat{M}^r = \begin{bmatrix} M_{11} & M_{12} & M_{13} & M_{14} & M_{15} & M_{16} & M_{17} \\ M_{21} & M_{22} & M_{23} & M_{24} & M_{25} & M_{26} & M_{27} \\ M_{31} & M_{32} & M_{33} & M_{34} & M_{35} & M_{36} & M_{37} \\ M_{41} & M_{42} & M_{43} & M_{44} & M_{45} & M_{46} & M_{47} \\ M_{51} & M_{52} & M_{53} & M_{54} & M_{55} & M_{56} & M_{57} \\ M_{61} & M_{62} & M_{63} & M_{64} & M_{65} & M_{66} & M_{67} \\ M_{71} & M_{72} & M_{73} & M_{74} & M_{75} & M_{76} & M_{77} \end{bmatrix} \quad (4.160)$$

\widehat{M}^r is the (7x7) mass matrix of the parallel robot with the components of,

$$M_{11} = m_1 a_1^2 + I_{1zz} + I_{2zz} + m_2 (\xi_2 - a_2)^2 + m_7 \xi_2^2 \quad (4.161)$$

$$M_{12} = 0 \quad (4.162)$$

$$M_{13} = 0 \quad (4.163)$$

$$M_{14} = m_7 \xi_2 g_7 \cos(\theta_1 - \theta_7 - \beta) \quad (4.164)$$

$$M_{21} = 0 \quad (4.165)$$

$$M_{22} = m_3 a_3^2 + I_{3zz} + m_4 (\xi_4 - a_4)^2 + I_{4zz} \quad (4.166)$$

$$M_{23} = 0 \quad (4.167)$$

$$M_{24} = 0 \quad (4.168)$$

$$M_{25} = 0 \quad (4.169)$$

$$M_{26} = 0 \quad (4.170)$$

$$M_{27} = 0 \quad (4.171)$$

$$M_{31} = 0 \quad (4.172)$$

$$M_{32} = 0 \quad (4.173)$$

$$M_{33} = m_5 a_5^2 + I_{5zz} + m_6 (\xi_6 - a_6)^2 + I_{6zz} \quad (4.174)$$

$$M_{34} = 0 \quad (4.175)$$

$$M_{35} = 0 \quad (4.176)$$

$$M_{36} = 0 \quad (4.177)$$

$$M_{37} = 0 \quad (4.178)$$

$$M_{41} = m_7 \xi_2 g_7 \cos(\theta_1 - \theta_7 - \beta) \quad (4.179)$$

$$M_{42} = 0 \quad (4.180)$$

$$M_{43} = 0 \quad (4.181)$$

$$M_{44} = m_7 a_7^2 + I_{7zz} \quad (4.182)$$

$$M_{45} = m_7 g_7 \sin(\theta_1 - \theta_7 - \beta) \quad (4.183)$$

$$M_{46} = 0 \quad (4.184)$$

$$M_{47} = 0 \quad (4.185)$$

$$M_{51} = 0 \quad (4.186)$$

$$M_{52} = 0 \quad (4.187)$$

$$M_{53} = 0 \quad (4.188)$$

$$M_{54} = m_7 g_7 \sin(\theta_1 - \theta_7 - \beta) \quad (4.189)$$

$$M_{55} = m_2 + m_7 \quad (4.190)$$

$$M_{56} = 0 \quad (4.191)$$

$$M_{57} = 0 \quad (4.192)$$

$$M_{61} = 0 \quad (4.193)$$

$$M_{62} = 0 \quad (4.194)$$

$$M_{63} = 0 \quad (4.195)$$

$$M_{64} = 0 \quad (4.196)$$

$$M_{65} = 0 \quad (4.197)$$

$$M_{66} = m_4 \quad (4.198)$$

$$M_{67} = 0 \quad (4.199)$$

$$M_{71} = 0 \quad (4.200)$$

$$M_{72} = 0 \quad (4.201)$$

$$M_{73} = 0 \quad (4.202)$$

$$M_{74} = 0 \quad (4.203)$$

$$M_{75} = 0 \quad (4.204)$$

$$M_{76} = 0 \quad (4.205)$$

$$M_{77} = m_6 \quad (4.206)$$

Equation (4.160) is subdivided into four matrices,

$$M_1 = \begin{bmatrix} M_{11} & M_{12} & M_{13} \\ M_{21} & M_{22} & M_{23} \\ M_{31} & M_{32} & M_{33} \end{bmatrix} \quad (4.207)$$

$$M_2 = \begin{bmatrix} M_{14} & M_{15} & M_{16} & M_{17} \\ M_{24} & M_{25} & M_{26} & M_{27} \\ M_{34} & M_{35} & M_{36} & M_{37} \end{bmatrix} \quad (4.208)$$

$$M_3 = \begin{bmatrix} M_{41} & M_{42} & M_{43} \\ M_{51} & M_{52} & M_{53} \\ M_{61} & M_{62} & M_{63} \\ M_{71} & M_{72} & M_{73} \end{bmatrix} \quad (4.209)$$

$$M_4 = \begin{bmatrix} M_{44} & M_{45} & M_{46} & M_{47} \\ M_{54} & M_{55} & M_{56} & M_{57} \\ M_{64} & M_{65} & M_{66} & M_{67} \\ M_{74} & M_{75} & M_{76} & M_{77} \end{bmatrix} \quad (4.210)$$

According to Equation (4.208) and Equation (4.209), M_3 is the transpose of M_2 .

$$\bar{Q} = [Q_1; Q_2; Q_3; Q_4; Q_5; Q_6; Q_7]^T \quad (4.211)$$

The components of \bar{Q} is given below.

$$Q_1 = 2m_2(\xi_2 - a_2)\dot{\xi}_2\dot{\theta}_1 + 2m_7\xi_2\dot{\xi}_2\dot{\theta}_1 + m_7\xi_2\dot{\theta}_7^2 g_7 \sin(\theta_1 - \theta_7 - \beta) + m_1 g a_1 \cos(\theta_1) + m_2 g (\xi_2 - a_2) \cos(\theta_1) + m_7 g \xi_2 \cos(\theta_1) \quad (4.212)$$

$$Q_2 = 2m_4(\xi_4 - a_4)\dot{\xi}_4\dot{\theta}_3 + m_3 g a_3 \cos(\theta_3) + m_4 g (\xi_4 - a_4) \cos(\theta_3) \quad (4.213)$$

$$Q_3 = 2m_6(\xi_6 - a_6)\dot{\xi}_6\dot{\theta}_5 + m_5 g a_5 \cos(\theta_5) + m_6 g (\xi_6 - a_6) \cos(\theta_5) \quad (4.214)$$

$$Q_4 = 2m_7\dot{\xi}_2\dot{\theta}_1 g_7 \cos(\theta_1 - \theta_7 - \beta) - 2m_7\dot{\xi}_2\dot{\theta}_7 g_7 \cos(\theta_1 - \theta_7 - \beta) + 2m_7\xi_2\dot{\theta}_1\dot{\theta}_7 g_7 \sin(\theta_1 - \theta_7 - \beta) - m_7\xi_2\dot{\theta}_7^2 g_7 \sin(\theta_1 - \theta_7 - \beta) + m_7 g g_7 \cos(\theta_7 + \beta) \quad (4.215)$$

$$Q_5 = -m_7\dot{\theta}_7^2 g_7 \cos(\theta_1 - \theta_7 - \beta) - m_2(\xi_2 - a_2)\dot{\theta}_1^2 - m_7\xi_2\dot{\theta}_1^2 + m_2 g \sin(\theta_1) + m_7 g \sin(\theta_1) \quad (4.216)$$

$$Q_6 = -m_4(\xi_4 - a_4)\dot{\theta}_3^2 + m_4 g \sin(\theta_3) \quad (4.217)$$

$$Q_7 = -m_6(\xi_6 - a_6)\dot{\theta}_5^2 + m_6 g \sin(\theta_5) \quad (4.218)$$

Equation (4.211) is subdivided into two matrices as,

$$\hat{Q}^a = [Q_1; Q_2; Q_3]^T \quad (4.219)$$

where \hat{Q}^a matrix consists of expressions corresponding to actuated joint variables.

and

$$\hat{Q}^u = [Q_4; Q_5; Q_6; Q_7]^T \quad (4.220)$$

where \hat{Q}^u matrix consists of expressions corresponding to unactuated joint variables.

$$\bar{D} = \begin{bmatrix} D_1(\dot{\theta}_1 - \dot{\phi}_1) \\ D_3(\dot{\theta}_3 - \dot{\phi}_3) \\ D_5(\dot{\theta}_5 - \dot{\phi}_5) \\ 0 \\ 0 \\ 0 \\ 0 \end{bmatrix} \quad (4.221)$$

$$\bar{K} = \begin{bmatrix} K_1(\theta_1 - \phi_1) \\ K_3(\theta_3 - \phi_3) \\ K_5(\theta_5 - \phi_5) \\ 0 \\ 0 \\ 0 \\ 0 \end{bmatrix} \quad (4.222)$$

$\vec{\lambda}$ is the (4x1) vector consisting of constraint reaction forces.

Equation (4.159) does not involve relating terms of the colliding body, so they are needed to be modified but firstly condition of the collision should be defined.

Body r (point mass) impacts with body s (manipulator) at the point P as shown in Figure 9.

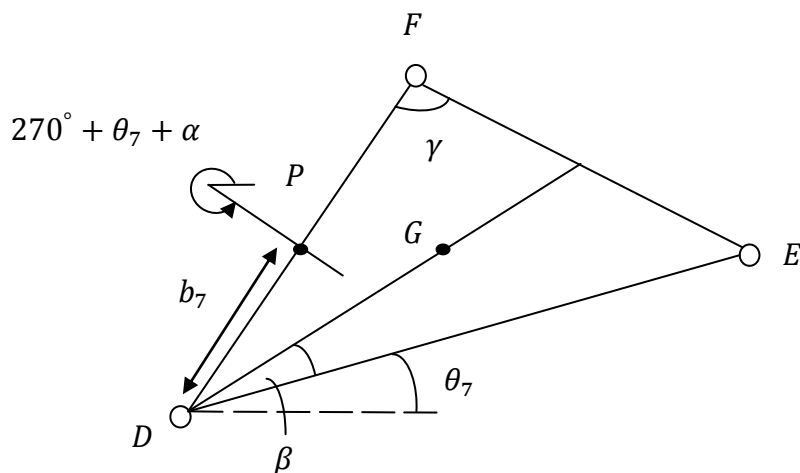

Figure 9 Point of Contact

Equation (4.159) becomes as,

$$\widehat{M}\ddot{\vec{\eta}} + \vec{Q} + \vec{D} + \vec{K} - \widehat{B}\vec{\lambda} + \vec{F}^p = 0 \quad (4.223)$$

The new (9x9) mass matrix \widehat{M} , involves both \widehat{M}^r derived previously in Equation (4.160) and the (2x2) diagonal mass matrix of the colliding object which results in,

$$\widehat{M} = \begin{bmatrix} \widehat{M}^r & 0 & 0 \\ 0 & m_A & 0 \\ 0 & 0 & m_A \end{bmatrix} \quad (4.224)$$

where m_A is the mass of colliding object.

\vec{Q} , \vec{D} and \vec{K} are same with the derived ones previously for Equation (4.159).

The new (4x9) B matrix, \widehat{B} involves terms related with the colliding object and results in,

$$\widehat{B} = [\widehat{B}^r \quad \vec{0} \quad \vec{0}] \quad (4.225)$$

\vec{F}^p is the vector of generalized impulsive forces due to impact force \vec{F}^I generated at the points of contact of the colliding bodies [13] and formulated as,

$$\vec{F}^p = \hat{v}^{sT} \vec{F}^I \quad (4.226)$$

The system equations of motion, corresponding to the second set of generalized coordinates as the following,

$$\hat{r}^r \ddot{\vec{\phi}} - \widehat{D}^a (\dot{\vec{\eta}}^a - \dot{\vec{\phi}}) - \widehat{K}(\vec{\eta}^a - \vec{\phi}) = \vec{T} \quad (4.227)$$

When both Equation (4.223) and Equation (4.227) are integrated respectively (see Equation 3.2 and Equation 3.3), it yields

$$\widehat{M}\Delta\dot{\vec{\eta}} - \widehat{B}^T \vec{\lambda} + \vec{L}^T H = 0 \quad (4.228)$$

$$\hat{r}^T \Delta \dot{\phi} = 0 \quad (4.229)$$

where

$\vec{\lambda}$: vector of impulses of constraint reaction forces.

$\vec{L}^T H$: vector of generalized impactive impulses where H is impulse of impact force

Equation (4.228) does not contain velocity components of the colliding body. So when they are added to the equation it becomes,

$$\hat{M} \Delta \dot{\mu} - \hat{B}^T \vec{\lambda} + \vec{L}^T H = 0 \quad (4.230)$$

where

$$\dot{\mu} = \begin{bmatrix} \dot{\eta} \\ \dot{x}_A \\ \dot{y}_A \end{bmatrix} \quad (4.231)$$

\dot{x}_A : x-component of velocity of the colliding body

\dot{y}_A : y-component of velocity of the colliding body

$$\vec{L} = \vec{z}^T (\hat{L}^s - \hat{L}^r) \quad (4.232)$$

\vec{z} is the unit vector of normal direction of impact and \hat{L}^s and \hat{L}^r are the velocity influence coefficient matrices. Unit vector for point P is defined as,

$$\vec{z}_P = \begin{bmatrix} \cos(\theta_7 + \alpha + 270^\circ) \\ \sin(\theta_7 + \alpha + 270^\circ) \end{bmatrix} \quad (4.233)$$

The velocity of the body s (manipulator) at Point P is

$$\vec{V}^s = \hat{v}^s \dot{\eta} = \hat{L}^s \dot{\mu} \quad (4.234)$$

where

$$\hat{L}^s = [\hat{v}^s \quad \hat{0}] \quad (4.235)$$

Equation (4.234) can be written explicitly as,

$$\begin{aligned} \vec{V}^s = & \left(\dot{\xi}_2 \cos(\theta_1) - \xi_2 \dot{\theta}_1 \sin(\theta_1) - b_7 \dot{\theta}_7 \sin(\theta_7 + \alpha) \right) \vec{i} + \left(\dot{\xi}_2 \sin(\theta_1) + \xi_2 \dot{\theta}_1 \cos(\theta_1) \right. \\ & \left. + b_7 \dot{\theta}_7 \cos(\theta_7 + \alpha) \right) \vec{j} \end{aligned} \quad (4.236)$$

since

$$\hat{v}^s = \begin{bmatrix} -\xi_2 \sin(\theta_1) & 0 & 0 & -b_7 \sin(\theta_7 + \alpha) & \cos(\theta_1) & 0 & 0 \\ \xi_2 \cos(\theta_1) & 0 & 0 & b_7 \cos(\theta_7 + \alpha) & \sin(\theta_1) & 0 & 0 \end{bmatrix} \quad (4.237)$$

So the influence coefficient matrix becomes,

$$\hat{L}^s = \begin{bmatrix} -\xi_2 \sin(\theta_1) & 0 & 0 & -b_7 \sin(\theta_7 + \alpha) & \cos(\theta_1) & 0 & 0 & 0 & 0 \\ \xi_2 \cos(\theta_1) & 0 & 0 & b_7 \cos(\theta_7 + \alpha) & \sin(\theta_1) & 0 & 0 & 0 & 0 \end{bmatrix} \quad (4.238)$$

Same procedure is valid in finding the velocity of the colliding body r.

$$\vec{V}^r = \hat{v}^r \begin{bmatrix} \dot{x}_A \\ \dot{y}_A \end{bmatrix} = \hat{L}^r \dot{\mu} \quad (4.239)$$

where

$$\hat{L}^r = [\hat{0} \quad \hat{1}] \quad (4.240)$$

$$\vec{V}^r = \dot{x}_A \vec{i} + \dot{y}_A \vec{j} \quad (4.241)$$

$$\hat{v}^r = \begin{bmatrix} 1 & 0 \\ 0 & 1 \end{bmatrix} \quad (4.242)$$

$$\hat{L}^r = \begin{bmatrix} 0 & 0 & 0 & 0 & 0 & 0 & 0 & 1 & 0 \\ 0 & 0 & 0 & 0 & 0 & 0 & 0 & 0 & 1 \end{bmatrix} \quad (4.243)$$

So that Equation (4.232) can be written for the point P as,

$$\vec{L}^T = \begin{bmatrix} -\xi_2 \sin(\theta_1) \cos(\theta_7 + \alpha + 270^\circ) + \xi_2 \cos(\theta_1) \sin(\theta_7 + \alpha + 270^\circ) \\ 0 \\ 0 \\ -b_7 \sin(\theta_7 + \alpha) \cos(\theta_7 + \alpha + 270^\circ) + b_7 \cos(\theta_7 + \alpha) \sin(\theta_7 + \alpha + 270^\circ) \\ \cos(\theta_1) \cos(\theta_7 + \alpha + 270^\circ) + \sin(\theta_1) \sin(\theta_7 + \alpha + 270^\circ) \\ 0 \\ 0 \\ -\cos(\theta_7 + \alpha + 270^\circ) \\ -\sin(\theta_7 + \alpha + 270^\circ) \end{bmatrix} \quad (4.244)$$

As it is previously stated it is assumed that collision occurs in a short period of time so that positions do not change during impact which yields (see Equation 3.11),

$$\hat{B} \Delta \dot{\vec{\mu}} = 0 \quad (4.245)$$

Equation 3.12 implies that the relative velocities of colliding bodies before and after collision at point P can be expressed as,

$$\vec{z} \cdot [\hat{v}_P^r(\tau^+) - \hat{v}_P^s(\tau^+)] = -e \vec{z} \cdot [\hat{v}_P^r(\tau^-) - \hat{v}_P^s(\tau^-)] \quad (4.246)$$

Equation 4.246 can be written in the form as (see Equation 3.13),

$$\vec{L} \Delta \dot{\vec{\mu}} = (e + 1) \vec{L} \dot{\vec{\mu}} \quad (4.247)$$

where e is the coefficient of restitution

According to Equation 4.230, Equation 4.245 and Equation 4.247 the system impulse-momentum equations can be written explicitly as,

$$\begin{bmatrix} \hat{M} & -\hat{B}^T & \vec{L}^T \\ \hat{B} & 0 & 0 \\ \vec{L} & 0 & 0 \end{bmatrix} \begin{bmatrix} \Delta \dot{\vec{\mu}} \\ \vec{\lambda} \\ H \end{bmatrix} = \begin{bmatrix} 0 \\ 0 \\ \alpha \end{bmatrix} \quad (4.248)$$

where

$$\alpha = (e + 1) \vec{L} \dot{\vec{\mu}} \quad (4.249)$$

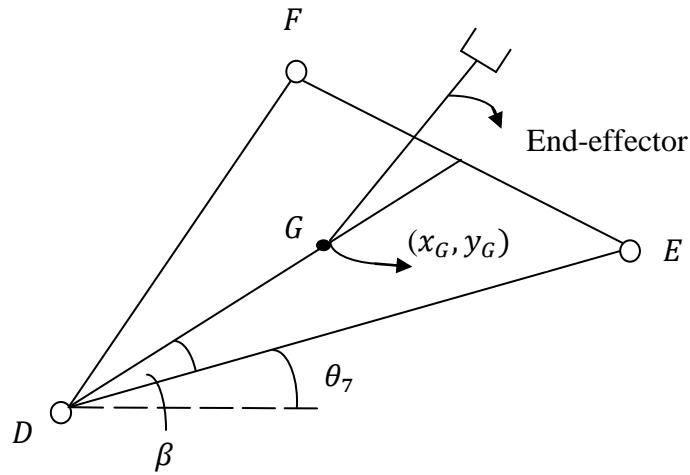

Figure 10 Position of the End-Effector

Since the end-effector is located on the seventh link of the parallel manipulator (see Figure 10), velocity vector of the seventh link is needed to be written to derive the task equations.

Position vector of the seventh link was derived previously (see Equation 4.26). The x-axis and y-axis components of this position vector are the followings respectively,

$$x_G = \xi_2 \cos(\theta_1) + g_7 \cos(\theta_7 + \beta) \quad (4.250)$$

$$y_G = \xi_2 \sin(\theta_1) + g_7 \sin(\theta_7 + \beta) \quad (4.251)$$

The vector of task space position is denoted as,

$$\vec{x} = \begin{bmatrix} x_1 \\ x_2 \\ x_3 \end{bmatrix} \quad (4.252)$$

where

$$x_1 = x_G \quad (4.253)$$

$$x_2 = y_G \quad (4.254)$$

$$x_3 = \theta_7 \quad (4.255)$$

θ_7 is the orientation of the end-effector.

In order to write the Jacobian matrix (\hat{F}) and the vector of task space velocity, first derivatives of Equation (4.253), Equation (4.254) and Equation (4.255) are needed to be found which are obtained as,

$$\dot{x}_1 = \dot{\xi}_2 \cos(\theta_1) - \xi_2 \dot{\theta}_1 \sin(\theta_1) - g_7 \dot{\theta}_7 \sin(\theta_7 + \beta) \quad (4.256)$$

$$\dot{x}_2 = \dot{\xi}_2 \sin(\theta_1) + \xi_2 \dot{\theta}_1 \cos(\theta_1) + g_7 \dot{\theta}_7 \cos(\theta_7 + \beta) \quad (4.257)$$

$$\dot{x}_3 = 0 \quad (4.258)$$

So the vector of task space velocity is,

$$\dot{\hat{x}} = \begin{bmatrix} \dot{x}_1 \\ \dot{x}_2 \\ \dot{x}_3 \end{bmatrix} \quad (4.259)$$

The relationship between the vector of task space velocity and the vector of joint variable velocities can be written as,

$$\dot{\hat{x}} = \hat{F} \dot{\hat{\eta}} \quad (4.260)$$

which yields the following equation

$$\begin{bmatrix} \dot{x}_G \\ \dot{y}_G \\ \dot{\theta}_7 \end{bmatrix} = \hat{F}_G \begin{bmatrix} \dot{\theta}_1 \\ \dot{\theta}_3 \\ \dot{\theta}_5 \\ \dot{\theta}_7 \\ \dot{\xi}_2 \\ \dot{\xi}_4 \\ \dot{\xi}_6 \end{bmatrix} \quad (4.261)$$

$$\hat{\Gamma}_G = \begin{bmatrix} -\xi_2 \sin(\theta_1) & 0 & 0 & -g_7 \sin(\theta_7 + \beta) & \cos(\theta_1) & 0 & 0 \\ \xi_2 \cos(\theta_1) & 0 & 0 & g_7 \cos(\theta_7 + \beta) & \sin(\theta_1) & 0 & 0 \\ 0 & 0 & 0 & 1 & 0 & 0 & 0 \end{bmatrix} \quad (4.262)$$

Equation (4.261) can be subdivided into two sets,

$$\begin{bmatrix} \dot{x}_G \\ \dot{y}_G \\ \dot{\theta}_7 \end{bmatrix} = \Gamma^a \begin{bmatrix} \dot{\theta}_1 \\ \dot{\theta}_3 \\ \dot{\theta}_5 \end{bmatrix} + \Gamma^u \begin{bmatrix} \dot{\theta}_7 \\ \dot{\xi}_2 \\ \dot{\xi}_4 \\ \dot{\xi}_6 \end{bmatrix} \quad (4.263)$$

where

$$\hat{\Gamma}_G^a = \begin{bmatrix} -\xi_2 \sin(\theta_1) & 0 & 0 \\ \xi_2 \cos(\theta_1) & 0 & 0 \\ 0 & 0 & 0 \end{bmatrix} \quad (4.264)$$

$\hat{\Gamma}_G^a$ is the Jacobian matrix corresponding to actuated variables.

$$\hat{\Gamma}_G^u = \begin{bmatrix} -g_7 \sin(\theta_7 + \beta) & \cos(\theta_1) & 0 & 0 \\ g_7 \cos(\theta_7 + \beta) & \sin(\theta_1) & 0 & 0 \\ 1 & 0 & 0 & 0 \end{bmatrix} \quad (4.265)$$

$\hat{\Gamma}_G^u$ is the Jacobian matrix corresponding to unactuated variables.

4.8 Control Law

In this section, an input/output relation (control torques and end effector positions are the inputs and the outputs for the system respectively) would be formed and the command signal of the control system would be derived. Hence, first of all unactuated joint variables ought to be written in terms of actuated joint variables which yields,

$$\hat{B}^u \dot{\bar{\eta}}^u = -\hat{B}^a \dot{\bar{\eta}}^a \quad (4.266)$$

By leaving the unactuated joint variables one side, Equation (4.266) can be written as,

$$\dot{\bar{\eta}}^u = -\hat{B}^{u-1} \hat{B}^a \dot{\bar{\eta}}^a \quad (4.267)$$

The first and the second derivatives of the previous expression are the followings respectively,

$$\ddot{\bar{\eta}}^u = -\hat{B}^{u-1} (\hat{B}^a \ddot{\bar{\eta}}^a + \dot{\hat{B}}^a \dot{\bar{\eta}}^a + \dot{\hat{B}}^u \dot{\bar{\eta}}^u) \quad (4.268)$$

$$\dddot{\bar{\eta}}^u = -\hat{B}^{u-1} (2\dot{\hat{B}}^u \ddot{\bar{\eta}}^u + 2\dot{\hat{B}}^a \ddot{\bar{\eta}}^a + \hat{B}^a \ddot{\bar{\eta}}^{\dot{a}} + \ddot{\hat{B}}^a \dot{\bar{\eta}}^a + \ddot{\hat{B}}^u \dot{\bar{\eta}}^u) \quad (4.269)$$

Equation (4.159) can be written in a separate form in terms of actuated and unactuated joint variables as,

$$\hat{M}_1 \ddot{\bar{\eta}}^a + \hat{M}_2 \ddot{\bar{\eta}}^u + \bar{Q}^a + \hat{D} (\dot{\bar{\eta}}^a - \dot{\bar{\phi}}) + \hat{K} (\bar{\eta}^a - \bar{\phi}) - \hat{B}^{aT} \bar{\lambda} = 0 \quad (4.270)$$

$$\hat{M}_3 \ddot{\bar{\eta}}^a + \hat{M}_4 \ddot{\bar{\eta}}^u + \bar{Q}^u - \hat{B}^{uT} \bar{\lambda} = 0 \quad (4.271)$$

Intermediate variable, $\bar{\lambda}$, should be eliminated. When Equation (4.267) is plugged into the recent two sets of equations (see Equations (4.270) and Equation (4.271), it yields [8],

$$\hat{M}^* \ddot{\bar{\eta}}^a + \bar{Q}^* + \hat{D} (\dot{\bar{\eta}}^a - \dot{\bar{\phi}}) + \hat{K} (\bar{\eta}^a - \bar{\phi}) = 0 \quad (4.272)$$

where

$$\hat{M}^* = (\hat{M}_1 - \hat{M}_2 \hat{B}^{u-1} \hat{B}^a) - \hat{B}^{aT} (\hat{B}^{u-1T}) (\hat{M}_3 - \hat{M}_4 \hat{B}^{u-1} \hat{B}^a) \quad (4.273)$$

$$\begin{aligned} \bar{Q}^* = & \left(-\hat{M}_2 \hat{B}^{u-1} \dot{\hat{B}}^a + \hat{B}^{aT} \hat{B}^{u-1T} \hat{M}_4 \hat{B}^{u-1} \dot{\hat{B}}^a \right) \dot{\bar{\eta}}^a \\ & + \left(-\hat{M}_2 \hat{B}^{u-1} \dot{\hat{B}}^u + \hat{B}^{aT} \hat{B}^{u-1T} \hat{M}_4 \hat{B}^{u-1} \dot{\hat{B}}^u \right) \dot{\bar{\eta}}^u + \bar{Q}^a - \hat{B}^{aT} \hat{B}^{u-1T} \bar{Q}^u \end{aligned} \quad (4.274)$$

In Equation (4.260), relationship between task space velocities and joint variable velocities were given. This equation can be modified as a combination of two separate Jacobian matrices ($\hat{\Gamma}_G^a$ and $\hat{\Gamma}_G^u$). If $\ddot{\eta}^u$ is also eliminated, we have the following relation,

$$\hat{f}\ddot{\eta}^a = -\hat{f}\dot{\eta}^a + \ddot{x} \quad (4.275)$$

where

$$\hat{f} = \hat{\Gamma}_G^a - \hat{\Gamma}_G^u \hat{B}^{u-1} \hat{B}^a \quad (4.276)$$

Since elastic joints transmit the control torques to the end-effector, the end-effector acceleration is not effected instantaneously. In order to get rid of this singularity, the equation needed to be written in the form of a fourth order equation [8]. Thus, the remaining intermediate variables, $\bar{\eta}^a$ and $\bar{\phi}$, should be eliminated which will result in,

$$\hat{N}\bar{u} + \hat{P} = \hat{T} + \hat{S}\hat{T} \quad (4.277)$$

$$\hat{N} = \hat{K}^{-1} \hat{r} \hat{M}^* \hat{f}^{-1} \quad (4.278)$$

\bar{u} is the vector of control signal, which can be written explicitly as,

$$\bar{u} = x_{desired}^{(4)} + C_1(\ddot{x}_{desired} - \ddot{x}) + C_2(\dot{x}_{desired} - \dot{x}) + C_3(x_{desired} - x) + C_4(x_{desired} - x) \quad (4.279)$$

where, C_1 , C_2 , C_3 and C_4 are feedback gains (see Section 4.11)

$$\hat{S} = \hat{K}^{-1} \hat{D} \quad (4.280)$$

$$\begin{aligned} \hat{P} = \hat{K}^{-1} \hat{r} \left[\left(-3\hat{M}^* \hat{f}^{-1} \dot{\hat{J}} + 2\hat{M}^* + \hat{D} \right) \ddot{\eta}^a + \left(-3\hat{M}^* \hat{f}^{-1} \ddot{\hat{J}} + \ddot{\hat{M}}^* + \hat{K} \right) \dot{\eta}^a + \left(-\hat{M}^* \hat{f}^{-1} \ddot{\hat{J}} \right) \dot{\eta}^a \right. \\ \left. + \ddot{\hat{Q}}^* \right] + \hat{K}^{-1} \hat{D} \left(\hat{M}^* \ddot{\eta}^a + \dot{\hat{M}}^* \dot{\eta}^a + \ddot{\hat{Q}}^* \right) + \hat{M}^* \ddot{\eta}^a + \ddot{\hat{Q}}^* \end{aligned} \quad (4.281)$$

4.9 Simulation Model

Simulink[®] is a simulation software program, integrated with Matlab[®] program and it enables to conduct simulations, model-based designs and automatic controls. It's a tool in Matlab[®] program hence it is easy to integrate the scripts written in Matlab[®] with Simulink[®] and create models [21]. In this study, all of the scripts corresponding to the dynamic equations and the control law are written in Matlab[®] and the control model is build in Simulink[®].

Configuration parameters of this study can be listed as,

- Simulation time: Start time (0 sec) and stop time (1.5 sec)
- Solver options-type: Fixed-step
- Solver options-solver: Euler (Ode 1)
- Fixed-step size: 0.000025 sec

Since it is a block diagram environment, systems modeled in this program as a series of blocks. In Figure 11, it is seen that control model build in this study consists of six major blocks (“controller”, “computed torque block”, “forward dynamics”, “act_2_eta”, “subsystem” and “forward kinematics”) which are also called subsystems. Due to the complexity of the diagram, it is better to arrange the system as a combination of subsystems.

After the initial conditions are given and trajectory of the desired motion is specified (which are all mentioned in Section 4.10), simulation starts.

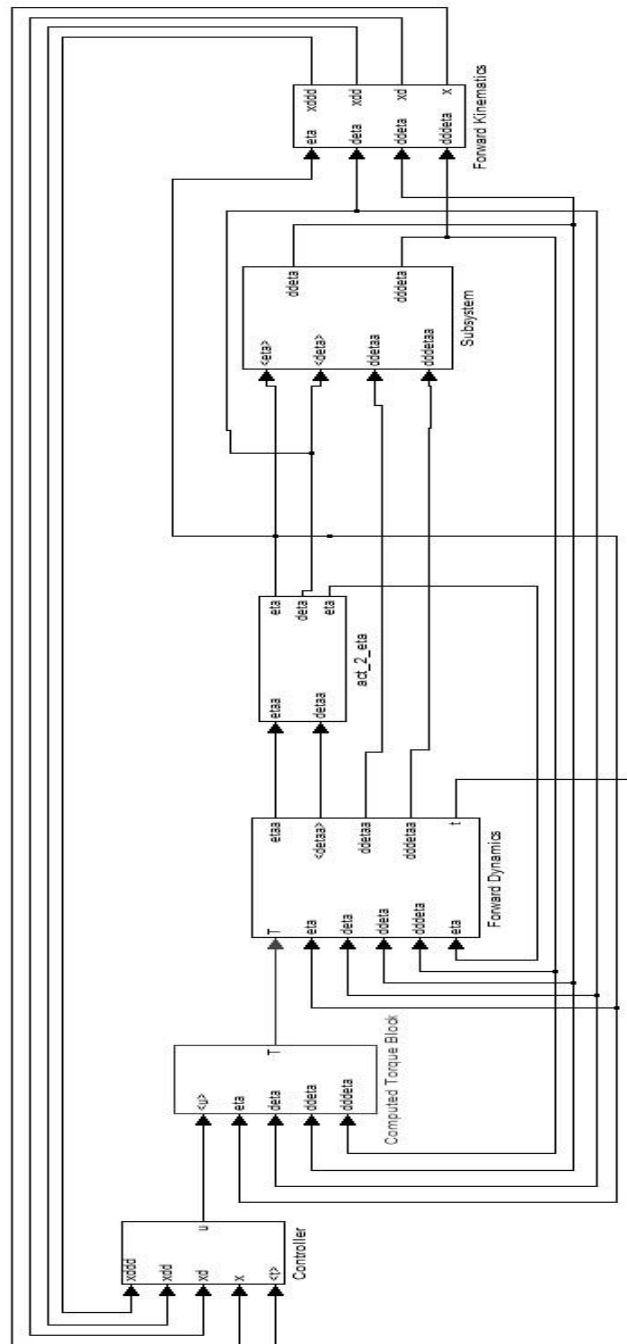

Figure 11 Overview of the Control Model

In the first subsystem, command input block, time signal which is generated by the clock located in the forward dynamics subsystem go into the corresponding Matlab[®] function blocks. Each of these blocks yield prescribed task space trajectory data (i.e. dddxtask which denotes the third derivative of the xtask). These values are subtracted from the real values (i.e. xddd which is the third derivative of the real x value) and the results are multiplied by the gains (i.e. C_1 in Gain 1). ITAE norm is used for these gains (values of the gains are provided

in Table 1, see Section 4.11). Therefore, the control signal \bar{u} , which is mentioned before in Equation (4.279), is formed with the combination of five signals. Both end-effector position data and end-effector velocity data are collected in this subsystem. They are symbolized as “xvec” and “xdvec” respectively in Figure 12.

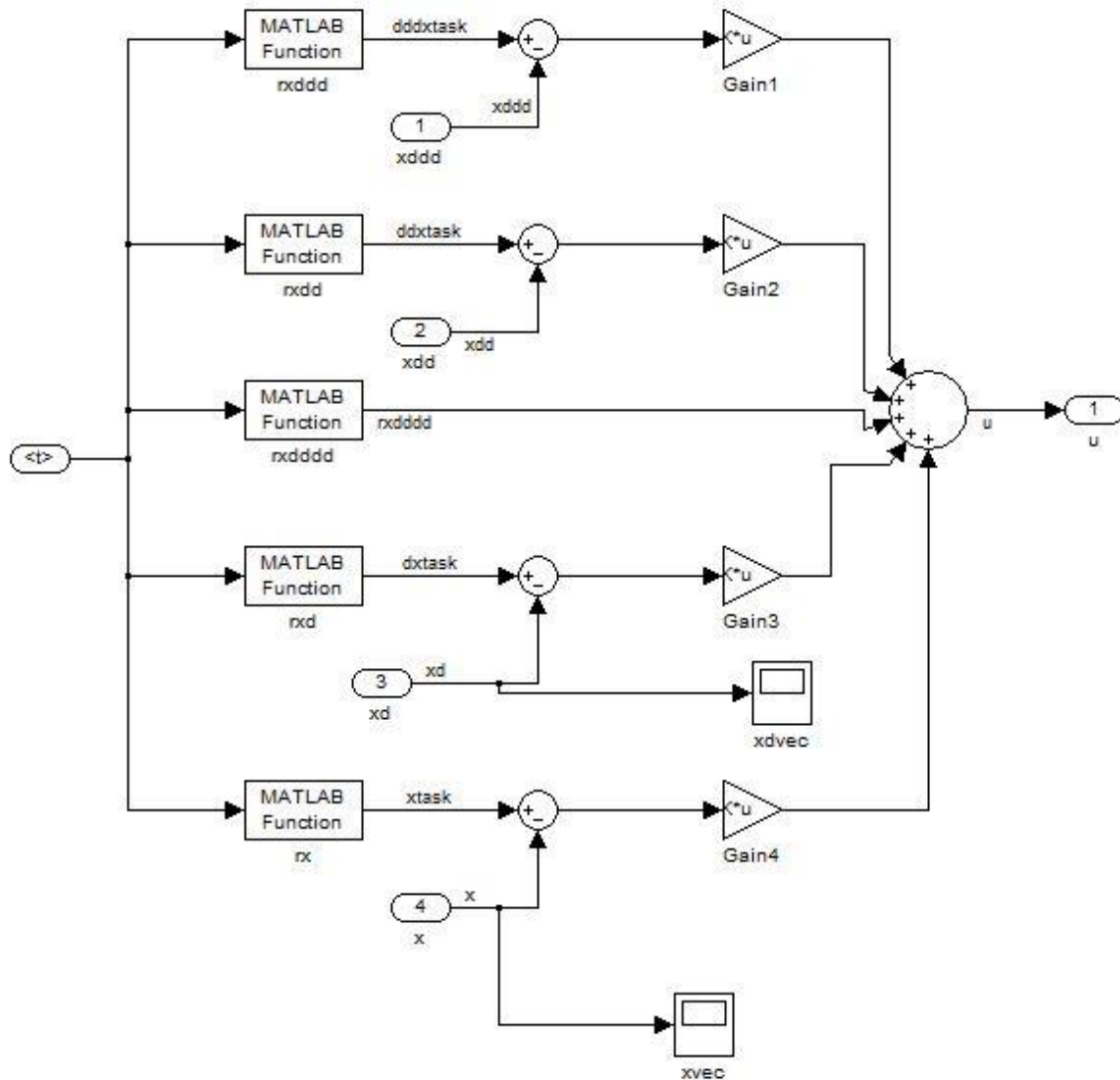

Figure 12 Command Input Block

Next subsystem is computed torque block. Inputs of this block are \bar{u} signal, position vector of the joint variables “eta” ($\bar{\eta}$), velocity vector of the joint variables “deta” ($\dot{\bar{\eta}}$), acceleration vector of the joint variables “ddeta” ($\ddot{\bar{\eta}}$) and jerk vector of the joint variables “dddeta” ($\dddot{\bar{\eta}}$). Matlab[®] function block includes inverse dynamics solution mentioned in Equation 4.277

which results in control torques denoted as T in Figure 13. Torque values are collected in the scope symbolized as “Tvec”.

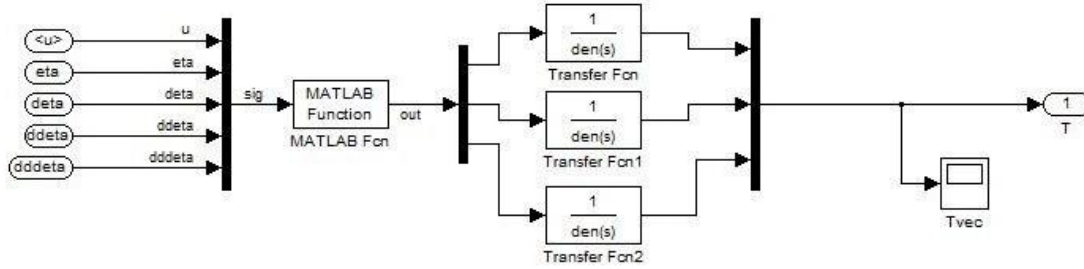

Figure 13 Computed Torque Block

The computed torque is applied to the system in the third subsystem, Forward Dynamics (see Figure 14). When Equation (4.272) and Equation (4.227) are written in the matrix form, it yields,

$$\begin{bmatrix} \hat{M}^* & 0 \\ 0 & \hat{I}^r \end{bmatrix} \begin{bmatrix} \ddot{\eta}^a \\ \ddot{\phi} \end{bmatrix} = \begin{bmatrix} -\vec{Q}^* - \hat{D}(\dot{\eta}^a - \dot{\phi}) - \hat{K}(\eta^a - \phi) \\ \hat{D}(\dot{\eta} - \dot{\phi}) + \hat{K}(\eta - \phi) + \vec{T} \end{bmatrix} \quad (4.282)$$

Equation 4.282 is modeled in this subsystem. In Figure 14, Matlab[®] functions and the gains involves the following,

- Matlab[®] Fcn 1: \vec{Q}^*
- Matlab[®] Fcn 3: \hat{M}^{*-1}
- Gain 1: \hat{I}^{r-1}
- Gain 3: \hat{D}
- Gain 5: \hat{K}

In the first row, starting with Gain 1, angular position vector of the actuator rotor, “fi” ($\vec{\phi}$) and angular velocity vector of the actuator rotor, “dfi” ($\dot{\vec{\phi}}$) are found by integrating the angular acceleration vector of the actuator rotor, “ddfii” ($\ddot{\vec{\phi}}$).

Next row, involving Matlab[®] Fcn3, position vector of the actuated joint variables “etaa” ($\vec{\eta}^a$), velocity vector of the actuated joint variables “detaa” ($\dot{\vec{\eta}}^a$) are found by integrating the acceleration vector of the actuated joint variables “ddetaa” ($\ddot{\vec{\eta}}^a$).

Initial values are assigned in these Integrator blocks and values used in integrator blocks are given in Section 4.10.

There is an also Impact block in this subsystem. Inputs of this block are “eta”, “detaa” and time. In this block, an if-else statement exists which check the impact time (see Figure 15). If time equals to the impact time, it increases “detaa” values and system continues with these new values of actuated variables.

Since acceleration vector of the actuated joint variables “ddetaa” and jerk vector of the actuated joint variables “dddetaa” ($\dddot{\vec{\eta}}^a$) cannot be measured unlike the measurable ones (“etaa”, “detaa”, “fi” and “dfi”), they are needed to be calculated. “ddetaa” can be found by using Equation(4.272) and by taking derivative of this equation, “dddetaa” can be also calculated. In Figure 14, these calculations are embedded in Matlab[®] Fcn 2 block.

Joint position values are collected in the scope symbolized as “etavec”. Deflection values are also calculated as “fi” values subtracted from “etaa” values and the results are stored in the scope symbolized as “defvec”.

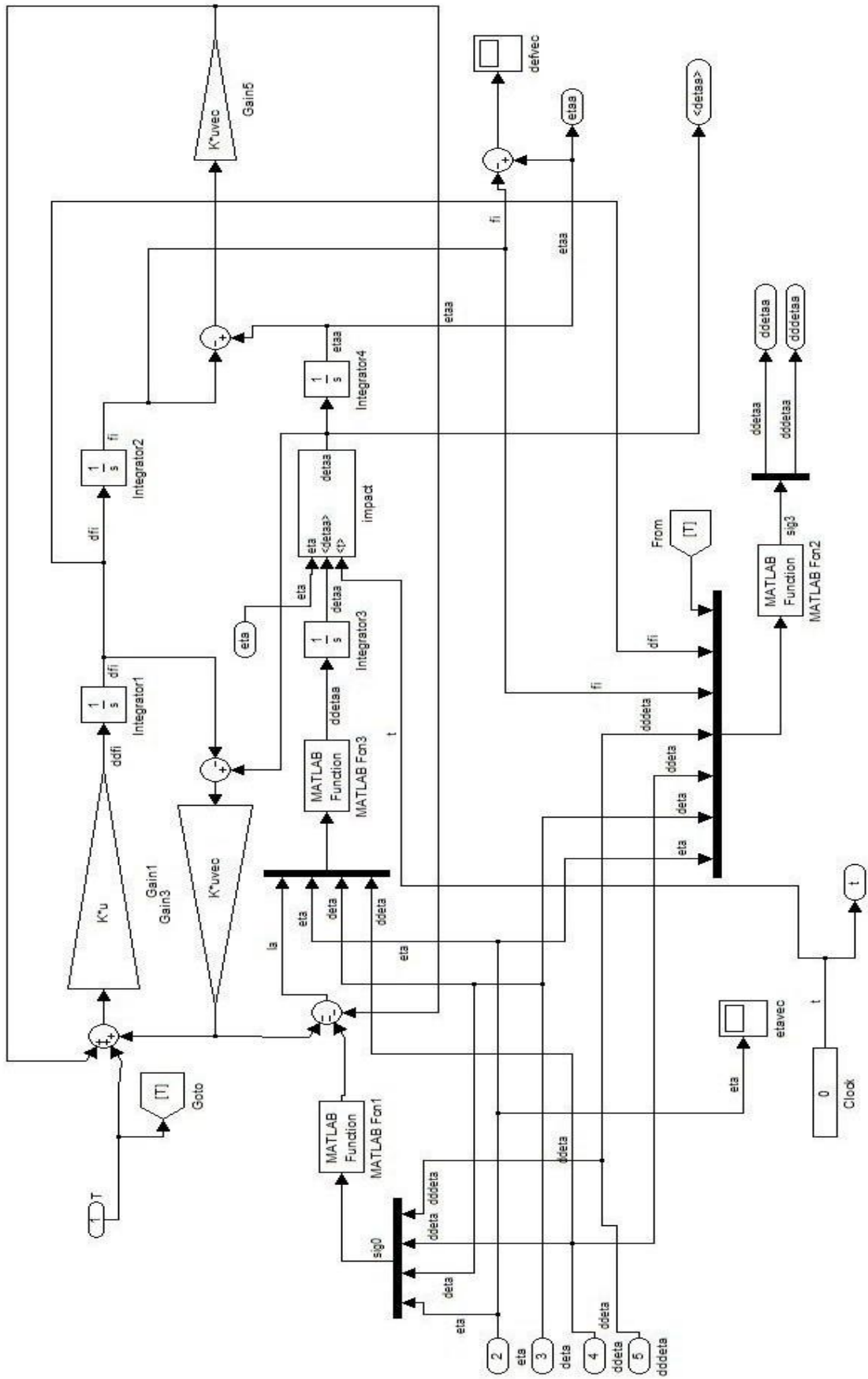

Figure 14 Forward Dynamics Block

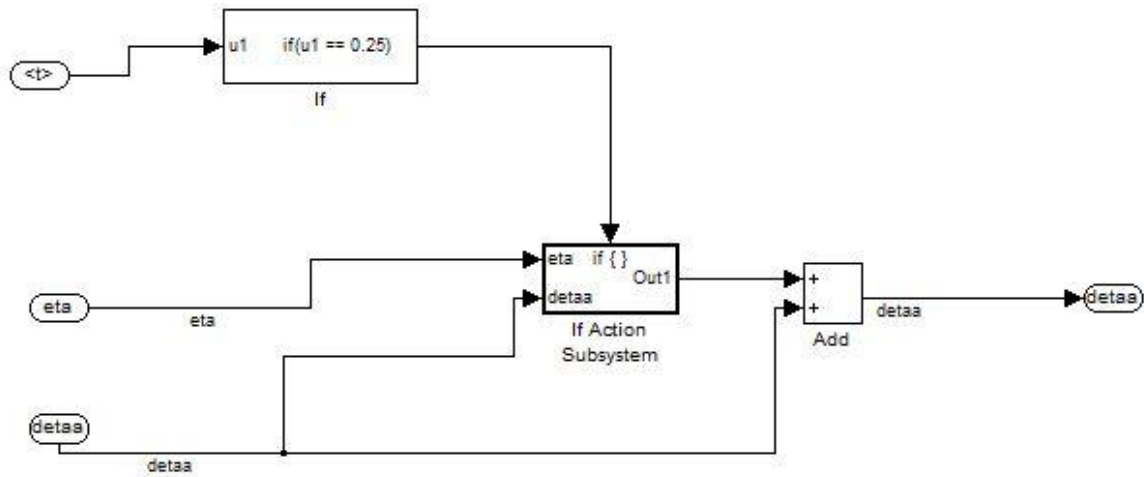

Figure 15 Impact Block

In the next subsystem, act_2_eta, position vector of the unactuated joint variables “etau” ($\bar{\eta}^u$), “etaa” and “detaa” are the input signals (see Figure 16). Matlab[®] Fcn 4 block contains Equation 4.267 which enables to find velocity vector of the unactuated joint variables “detau” ($\dot{\bar{\eta}}^u$). “etau” is found by integrating “detau”.

Since “eta” consists of both actuated and unactuated joint variables (see Equation 4.2), corresponding actuated and unactuated joint variable position vectors, “etaa” and “etau” respectively, are combined together and “eta” signal is formed.

In the same manner, “deta” is formed as a combination of actuated and unactuated joint variable velocity vectors which are “detaa” and “detau” respectively.

Joint velocity values are collected in the scope symbolized as “detavec”. And the output signals of this subsystem are “eta” and “deta”.

In the subsystem, called as, Subsystem, it contains one Matlab[®] Function (see Figure 17) which involves Equation (4.268) and Equation (4.269). Those equations enable to find acceleration vector of the unactuated joint variables “ddetau” ($\ddot{\bar{\eta}}^u$) and jerk vector of the unactuated joint variables “dddetau” ($\dddot{\bar{\eta}}^u$). And then likewise, “ddeta” and “dddeta” are found as combination of corresponding actuated and unactuated variable vectors.

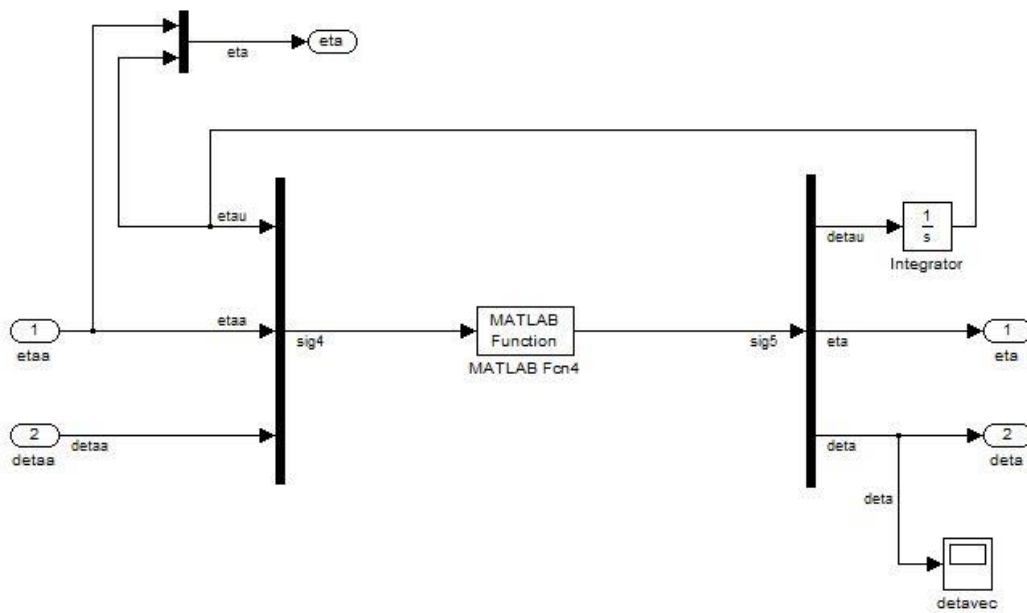

Figure 16 act_2_eta Block

Lastly, task space position vector (\vec{x}), task space velocity vector ($\dot{\vec{x}}$), task space acceleration vector ($\ddot{\vec{x}}$) and task space jerk vector ($\dddot{\vec{x}}$) are found in “Forward Kinematics” (see Figure 18) by using Equation 4.253, Equation 4.254, Equation 4.255 and their first, second and third derivatives.

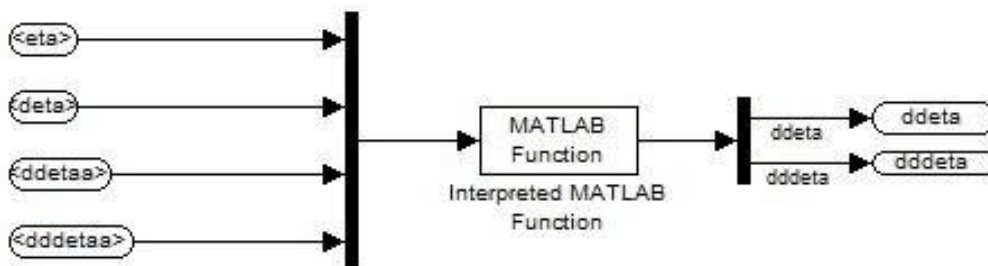

Figure 17 Subsystem Block

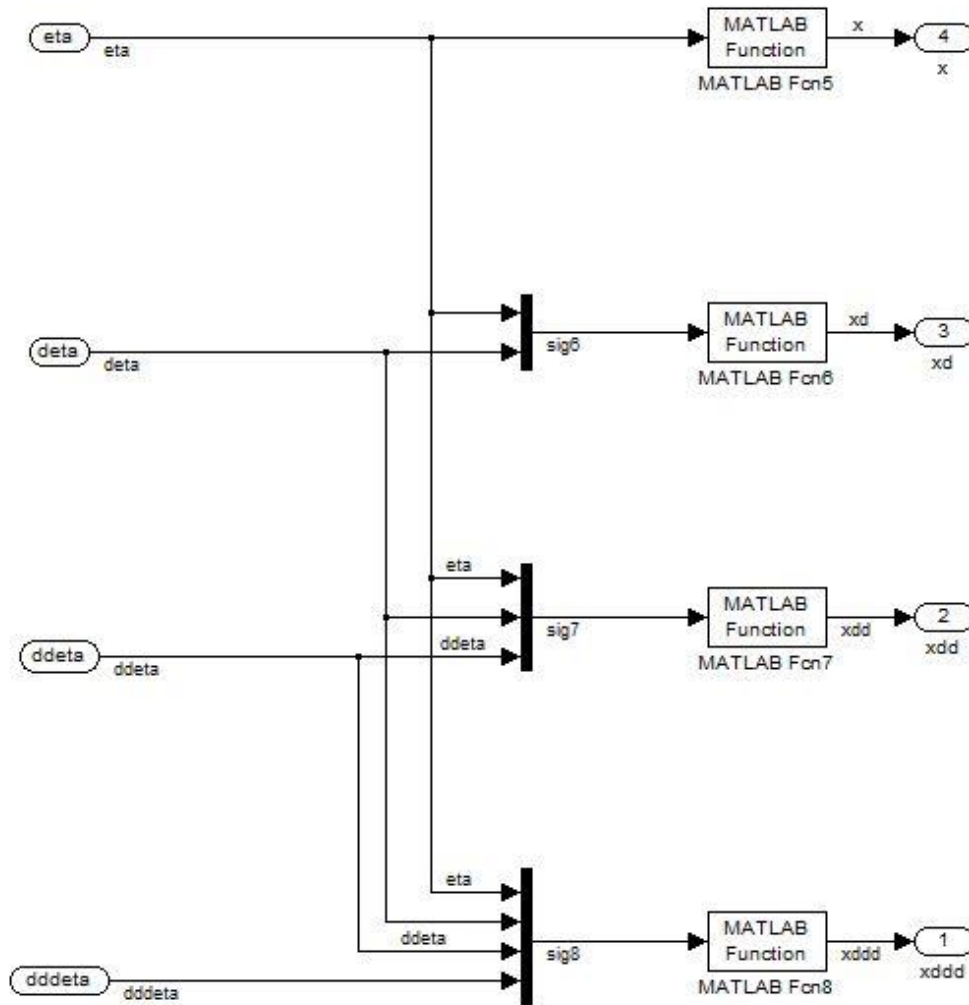

Figure 18 Forward Kinematics Block

4.10 Initial Values and Desired Trajectory Motion

The initial values and the desired trajectory used in this simulation are listed as,

The initial positions of the active joints:

$$\theta_1 = 45^\circ \quad (4.282)$$

$$\theta_3 = 155^\circ \quad (4.283)$$

$$\theta_5 = 255^\circ \quad (4.284)$$

The initial lengths of the passive joints:

$$\xi_2 = 0.756 \text{ m} \quad (4.285)$$

$$\xi_4 = 1.177 \text{ m} \quad (4.286)$$

$$\xi_2 = 0.901 \text{ m} \quad (4.287)$$

The initial position of the end-effector:

$$x_G = 0.745 \text{ m} \quad (4.288)$$

$$y_G = 0.631 \text{ m} \quad (4.289)$$

$$\theta_7 = -5.38^\circ \quad (4.290)$$

Desired trajectory motion:

$$x_G^d = \begin{cases} 0.70 + \frac{0.35}{T} \left[t - \frac{T}{2\pi} \sin \frac{2\pi T}{T} \right] m & 0 \leq t \leq T \\ 1.05 \text{ m} & \end{cases} \quad (4.291)$$

$$y_G^d = \begin{cases} 0.60 + \frac{0.20}{T} \left[t - \frac{T}{2\pi} \sin \frac{2\pi T}{T} \right] m & 0 \leq t \leq T \\ 0.80 \text{ m} & \end{cases} \quad (4.292)$$

$$\theta_7^d = \begin{cases} 0 + \frac{25}{T} \left[t - \frac{T}{2\pi} \sin \frac{2\pi T}{T} \right] deg & 0 \leq t \leq T \\ 25 \text{ deg} & \end{cases} \quad (4.293)$$

The initial torques:

$$T_1 = 0 \text{ N.m} \quad (4.294)$$

$$T_2 = 0 \text{ N.m} \quad (4.295)$$

$$T_3 = 0 \text{ N.m} \quad (4.296)$$

The initial angular positions of the actuator rotors:

$$\phi_1 = 45^\circ \quad (4.297)$$

$$\phi_3 = 155^\circ \quad (4.298)$$

$$\phi_5 = 255^\circ \quad (4.299)$$

4.11 Data

For the simplicity, a M-file, called as data, is created which includes all the constant values. Necessary values used in a certain Matlab[®] Function are directly loaded from this M-file which prevents drops in system speed. These values can be tabulated as,

Feedback Gains	Values
C_{1kk}	$2.1\omega_{ok}$
C_{2kk}	$3.4\omega_{ok}^2$
C_{3kk}	$2.7\omega_{ok}^3$
C_{4kk}	ω_{ok}^4

Table 1 Feedback Gains

where $k = 1,2,3$ and ω_{ok} is a positive constant used in feedback gain matrices.

For all simulations in this study,

$$\omega_o = 50. \quad (4.300)$$

Symbol	Value	Symbol	Value
L_7	0.4 m	a_5	0.3 m
g_7	0.231 m	a_6	0.3 m
b_7	0.15 m	d_0	2 m
a_1	0.3 m	d_1	1.732 m
a_2	0.3 m	d_2	1 m
a_3	0.3 m	α	60°
a_4	0.3 m	β	30°

Table 2 Dimensions and Angles

Symbol	Value	Symbol	Value
m_1	5 kg	I_{2zz}	0.15 kg.m ²
m_2	5 kg	I_{3zz}	0.15 kg.m ²
m_3	5 kg	I_{4zz}	0.15 kg.m ²
m_4	5 kg	I_{5zz}	0.15 kg.m ²
m_5	5 kg	I_{6zz}	0.15 kg.m ²
m_6	5 kg	I_{7zz}	0.23 kg.m ²
m_7	7 kg	I_{1zz}^r	2x10 ⁻⁵ kg.m ²
m_A	5 kg	I_{3zz}^r	2x10 ⁻⁵ kg.m ²
I_{1zz}	0.15 kg.m ²	I_{5zz}^r	2x10 ⁻⁵ kg.m ²

Table 3 Link Masses, Mass of the Colliding Body, Link Inertias and Rotor Inertias

Symbol	Value
r_1	100
r_3	100
r_5	100

Table 4 Gear Ratios

Symbol	Value	Symbol	Value
D_1	0.0355 N.m.s/rad	K_1	2500 N.m/rad
D_3	0.0379 N.m.s/rad	K_3	2500 N.m/rad
D_5	0.0402 N.m.s/rad	K_5	2500 N.m/rad

Table 5 Damping and Spring Constants

Symbol	Value
\dot{x}_A	1.5 m/s
\dot{y}_A	-1 m/s
e	0.9

Table 6 Velocity Components of the Colliding Body and Coefficient of Restitution

4.12 Simulations and Results

Case I

- No impact, no modeling error

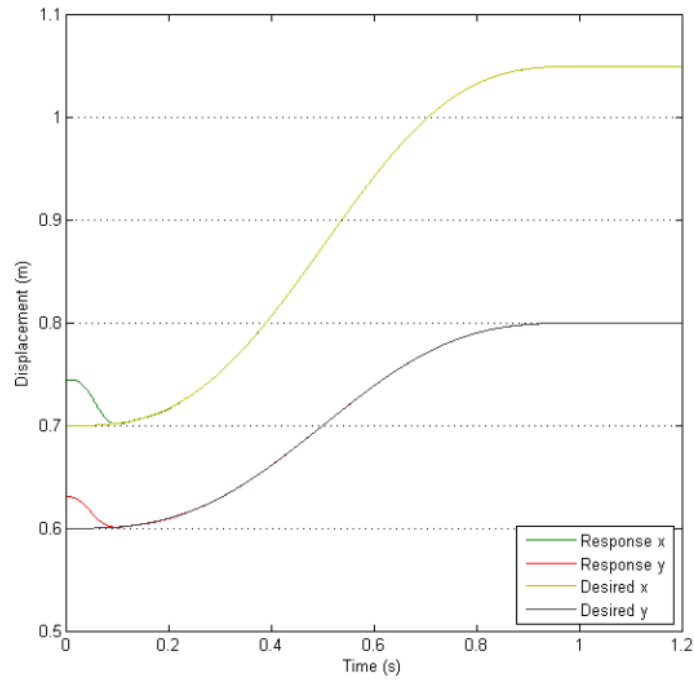

Figure 19 Position Response (x_G and y_G)

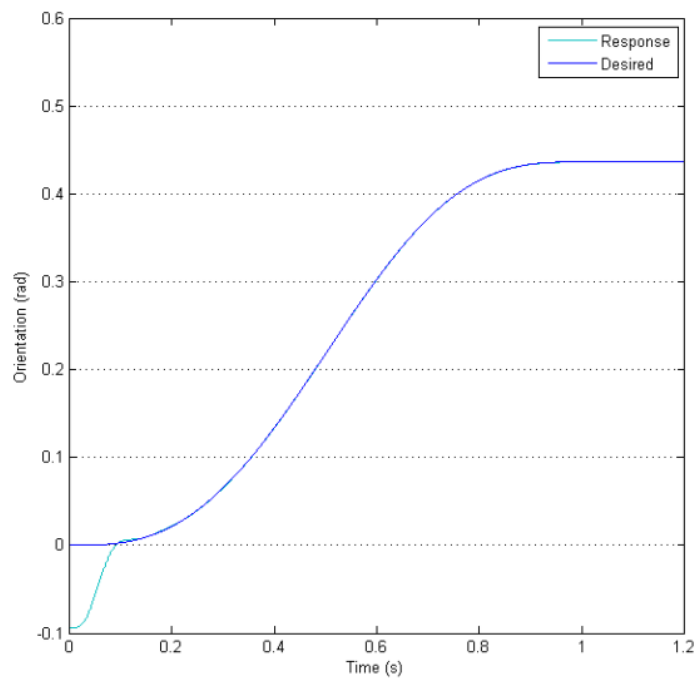

Figure 20 Position Response (θ_7)

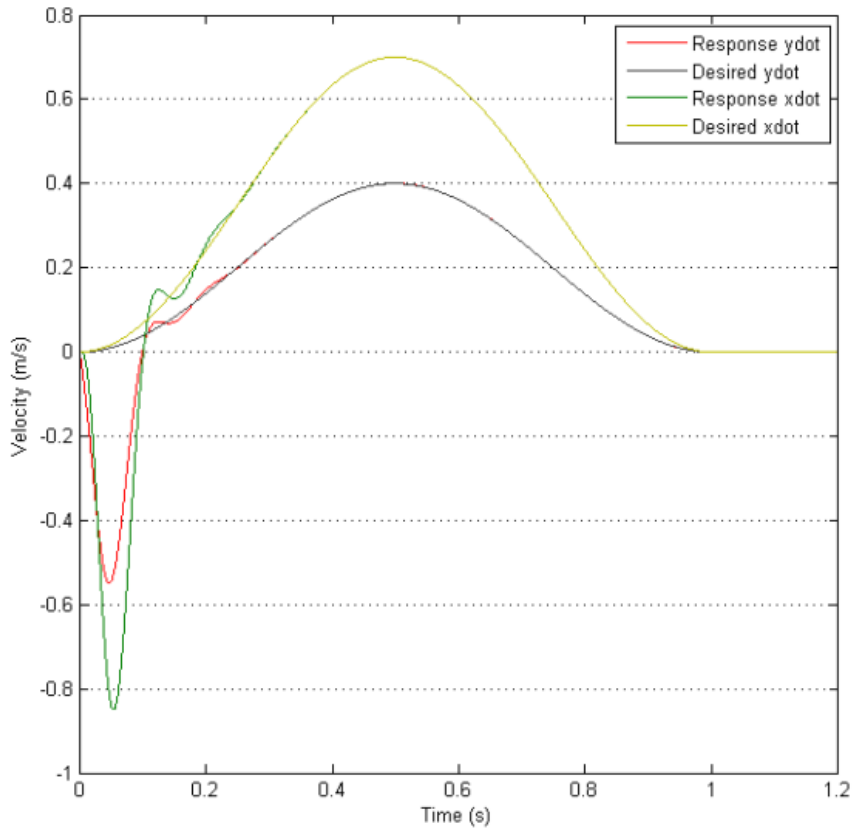

Figure 21 Velocity Response (\dot{x}_G and \dot{y}_G)

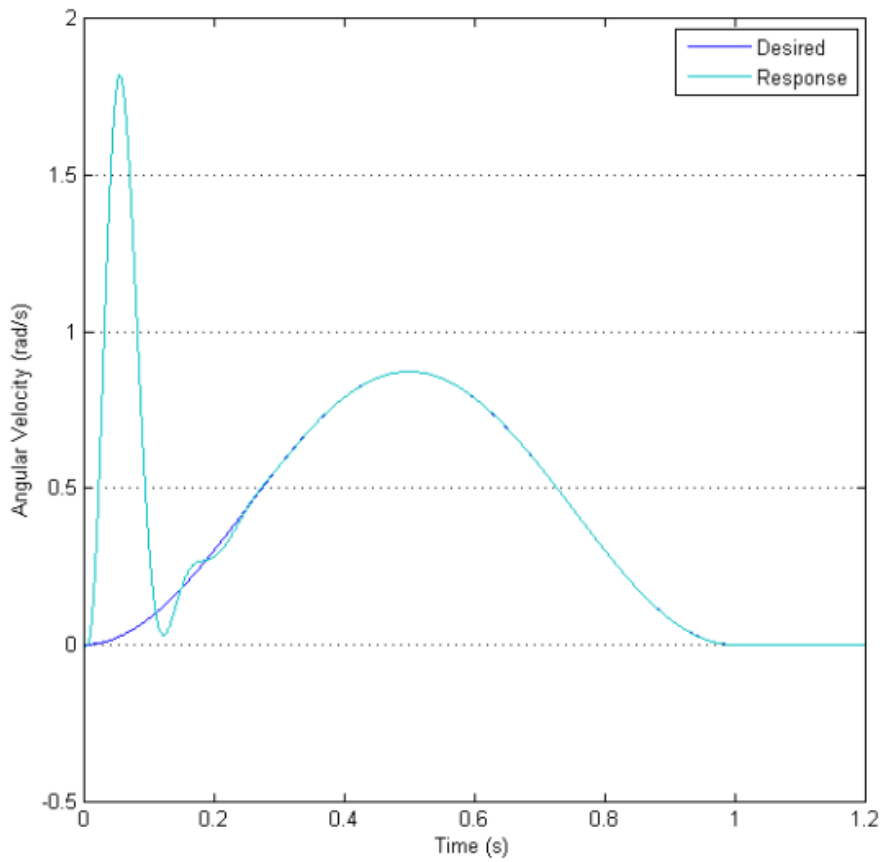

Figure 22 Velocity Response ($\dot{\theta}_7$)

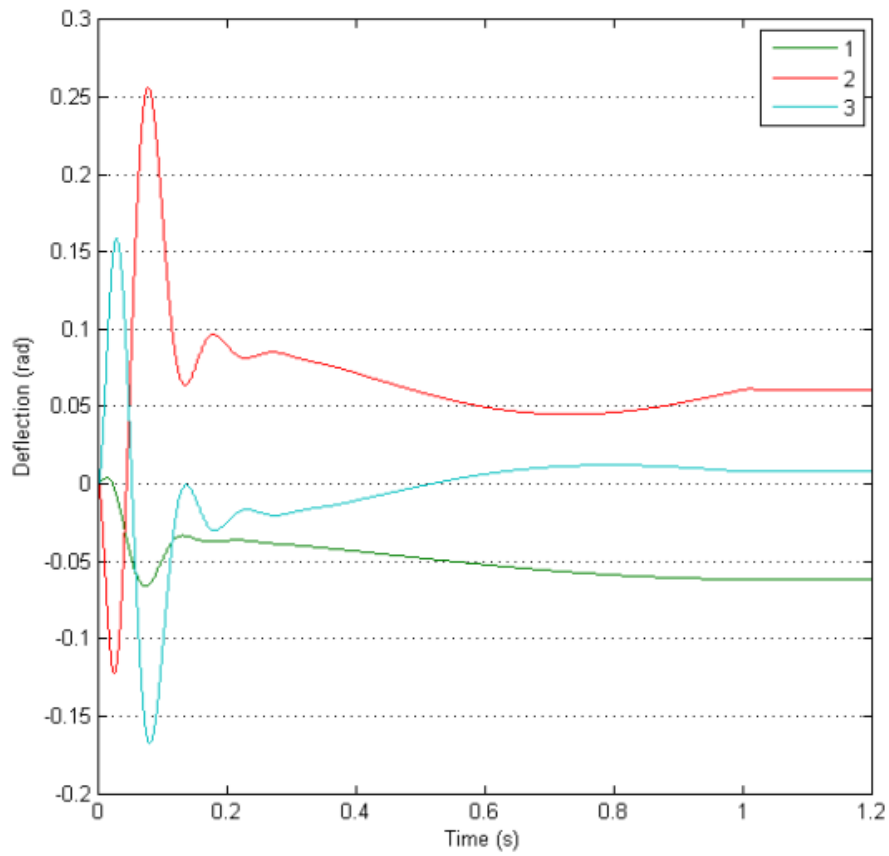

Figure 23 Deflections: 1) $\theta_1 - \phi_1$ 2) $\theta_3 - \phi_3$ 3) $\theta_5 - \phi_5$

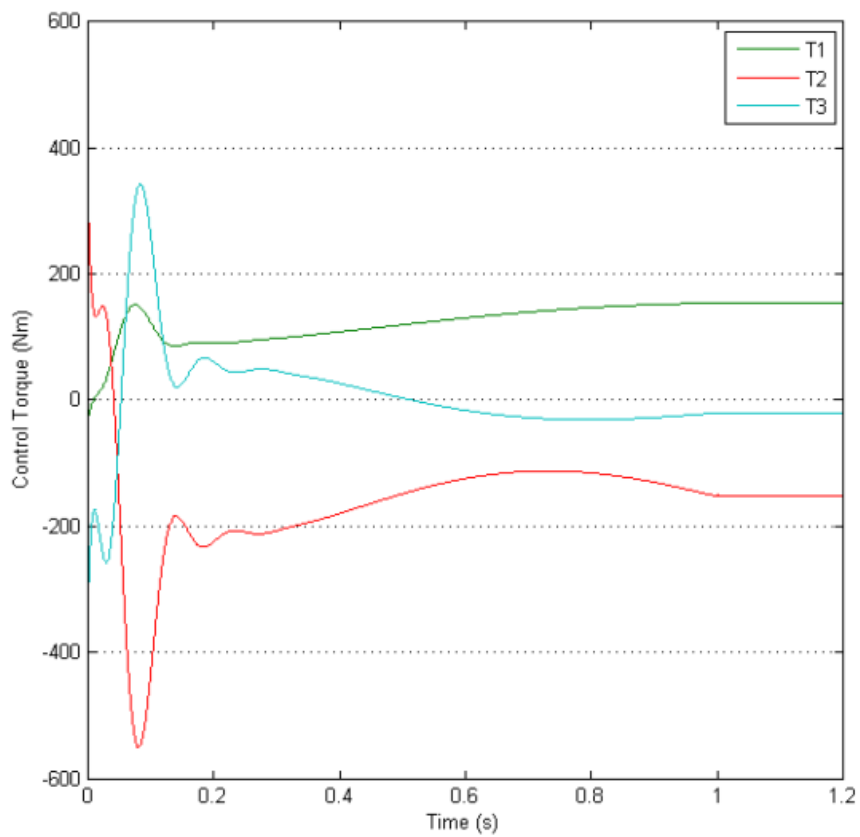

Figure 24 Control Torques

Case II

- No impact, 10% modeling error

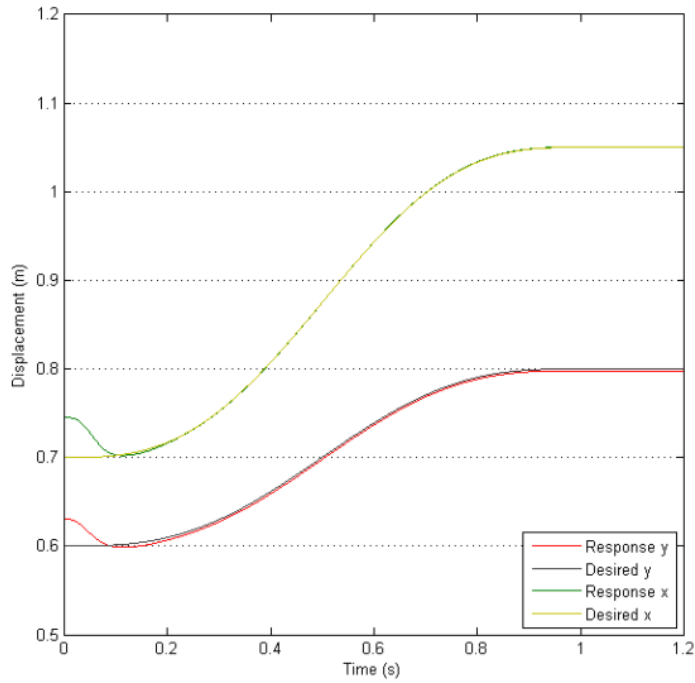

Figure 25 Position Response (x_G and y_G)

In Figure 25, $ess_{x_G} = 0.000014$ [m] and $ess_{y_G} = 0.002215$ [m]

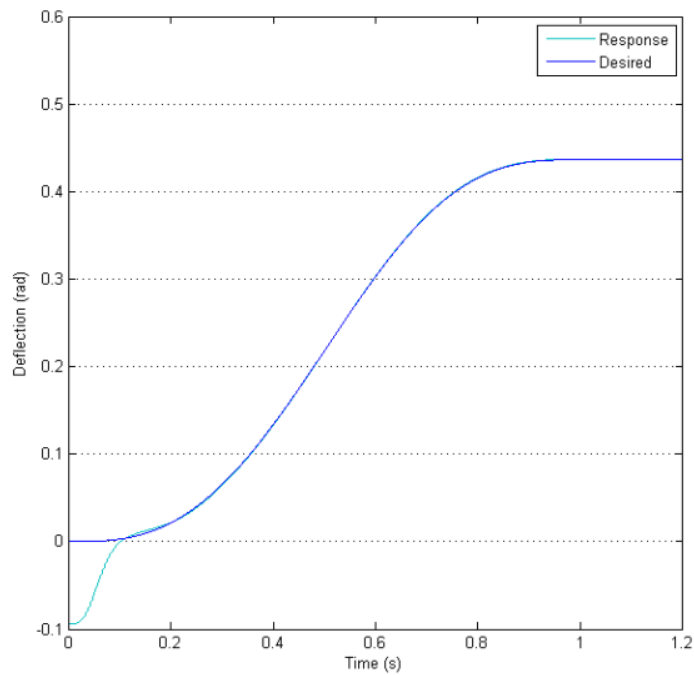

Figure 26 Position Response (θ_7)

In Figure 26, $ess_{\theta_7} = 0.0000007$ [rad]

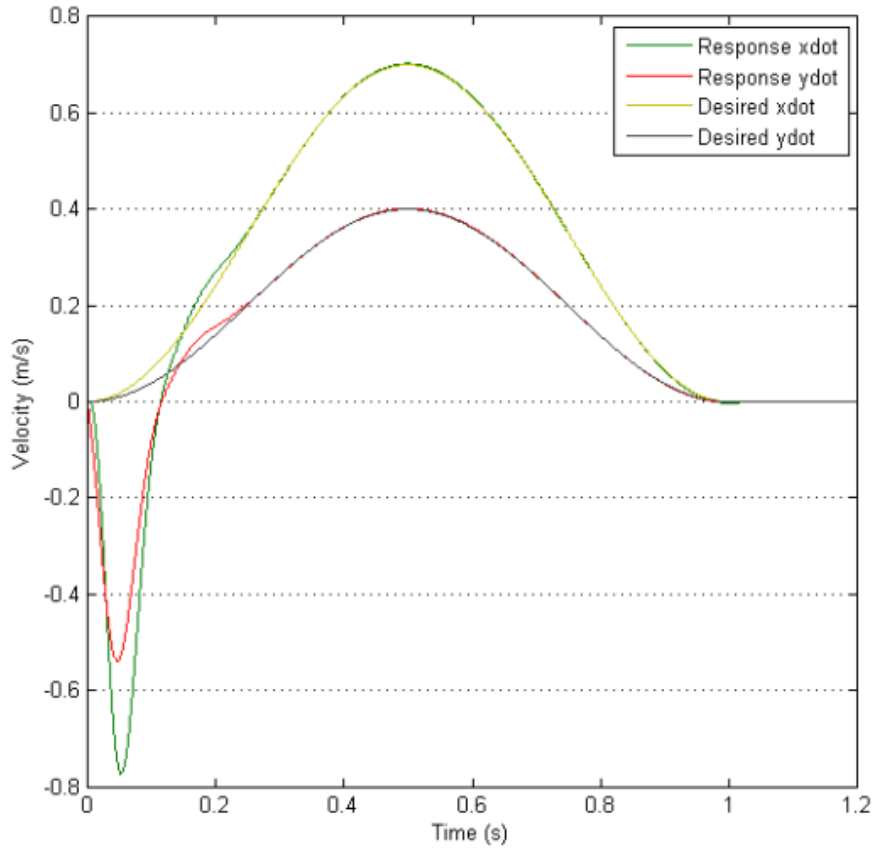

Figure 27 Velocity Response (\dot{x}_G and \dot{y}_G)

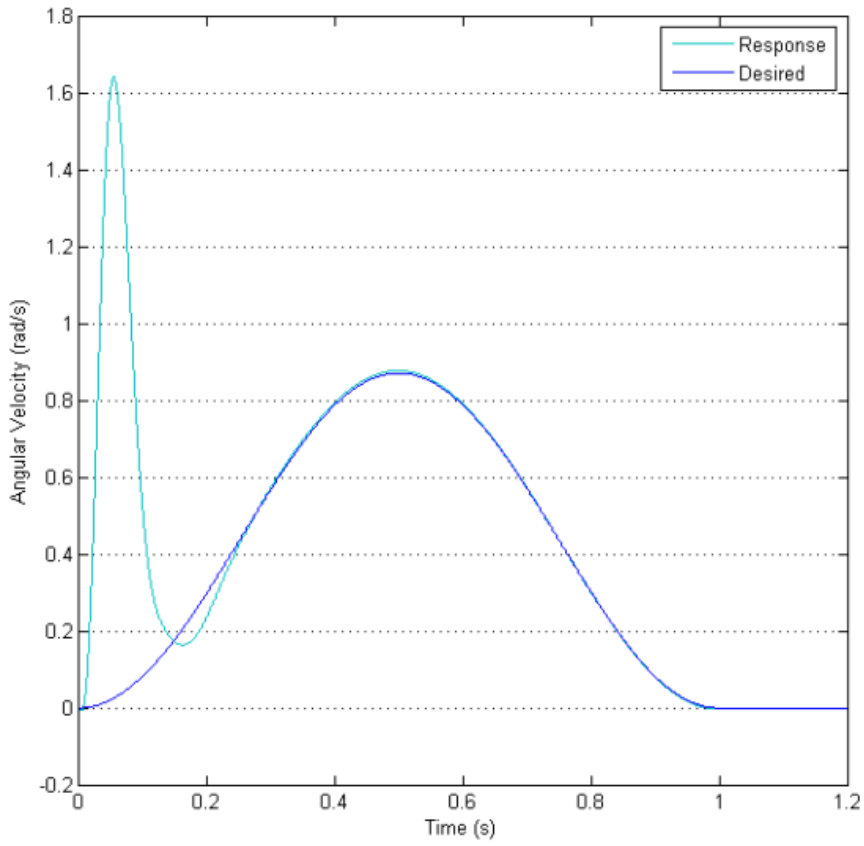

Figure 28 Velocity Response ($\dot{\theta}_7$)

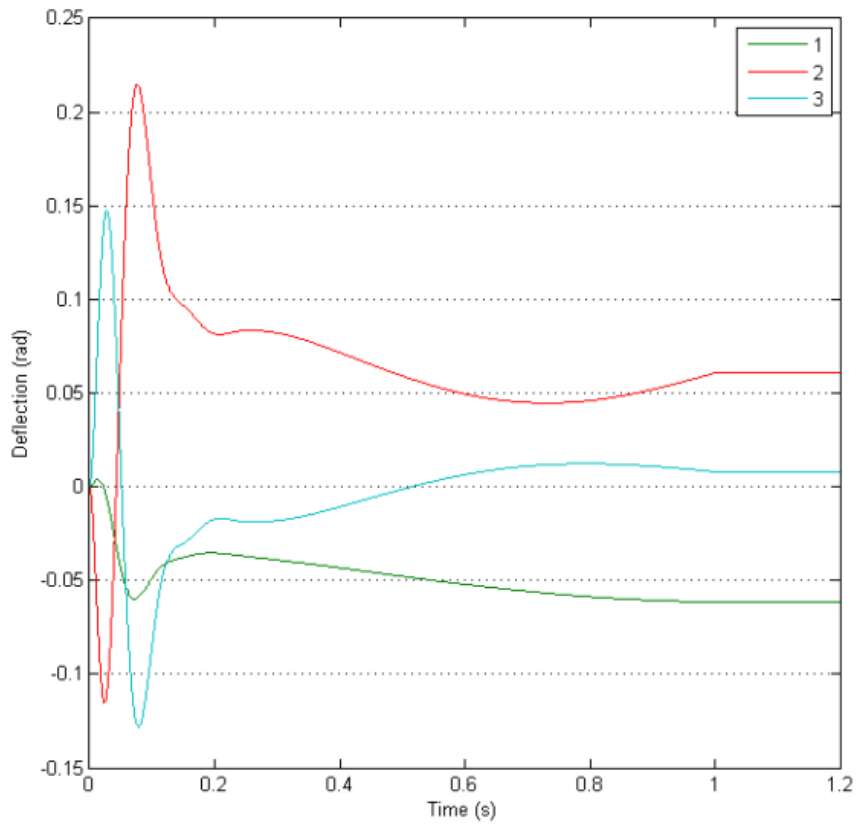

Figure 29 Deflections: 1) $\theta_1 - \phi_1$ 2) $\theta_3 - \phi_3$ 3) $\theta_5 - \phi_5$

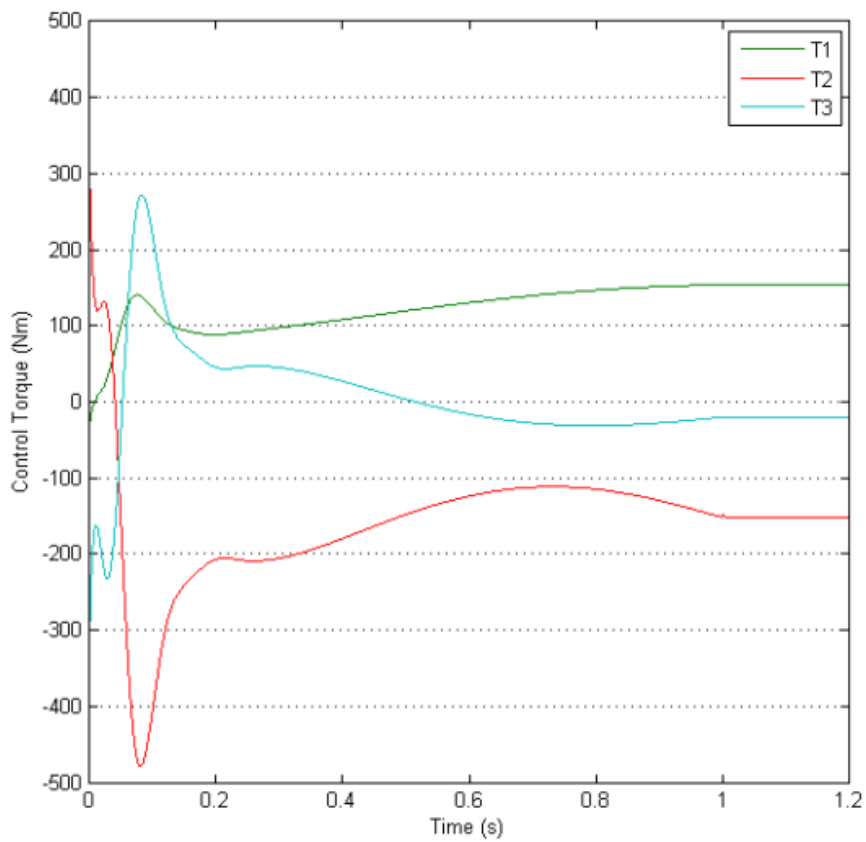

Figure 30 Control Torques

Case III

- Impact ($t = 0.25$ s), no modeling error

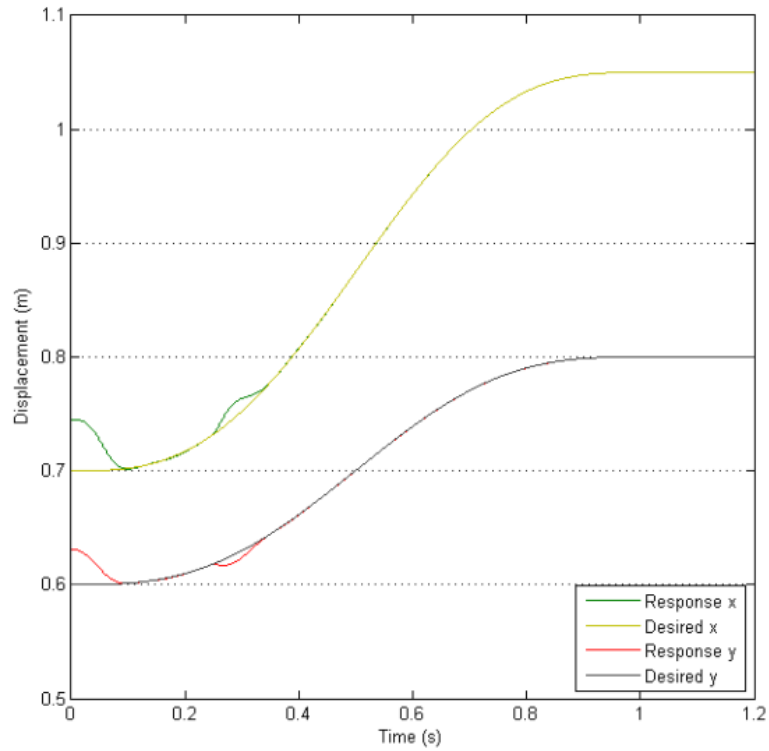

Figure 31 Position Response (x_G and y_G)

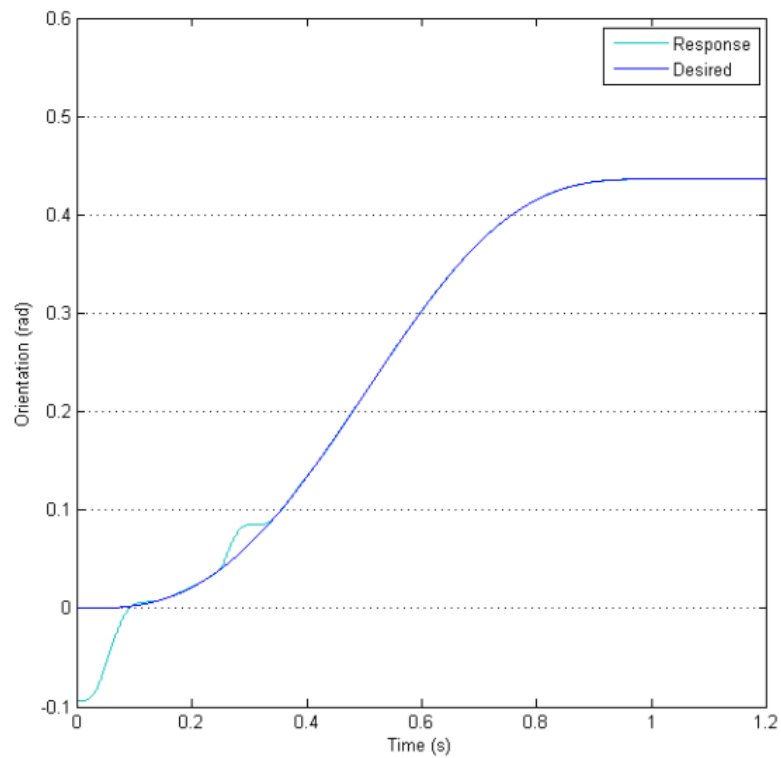

Figure 32 Position Response (θ_7)

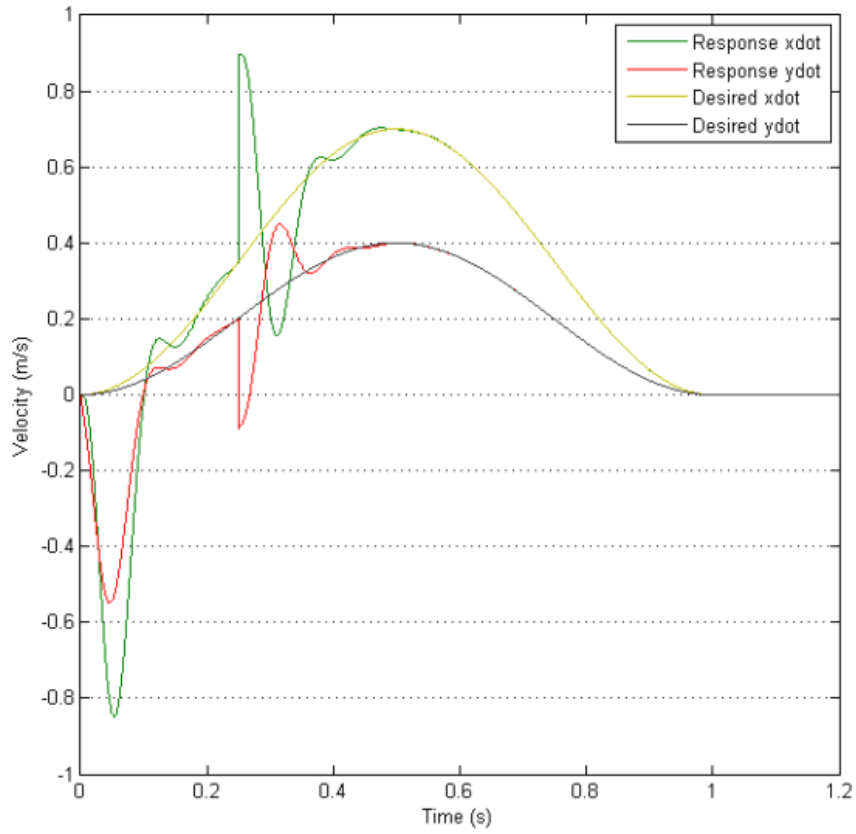

Figure 33 Velocity Response (\dot{x}_G and \dot{y}_G)

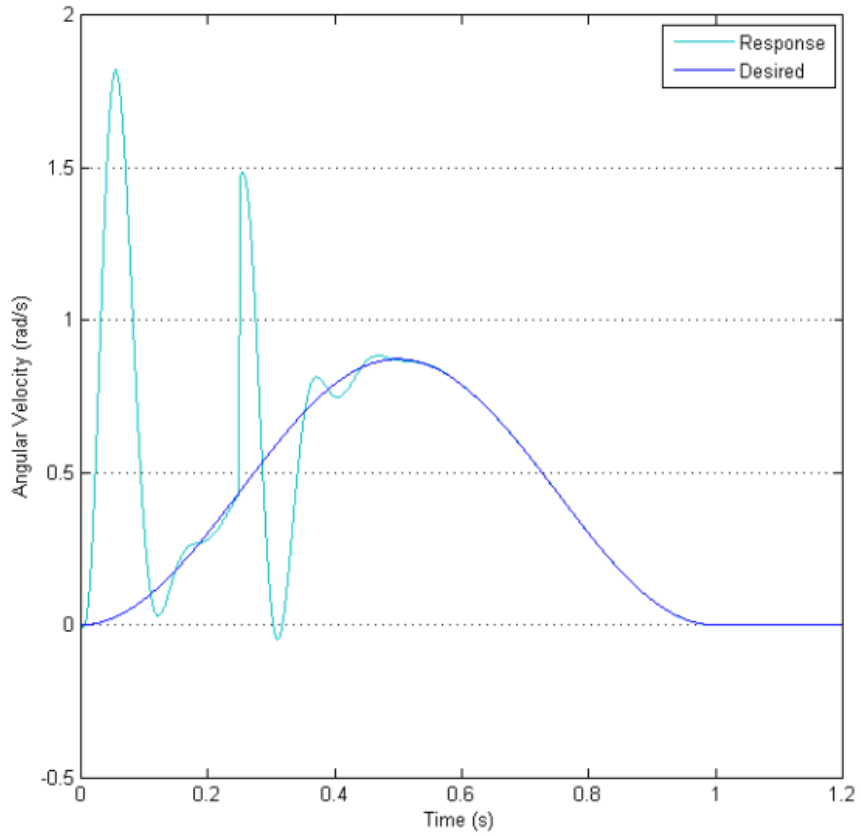

Figure 34 Velocity Response ($\dot{\theta}_7$)

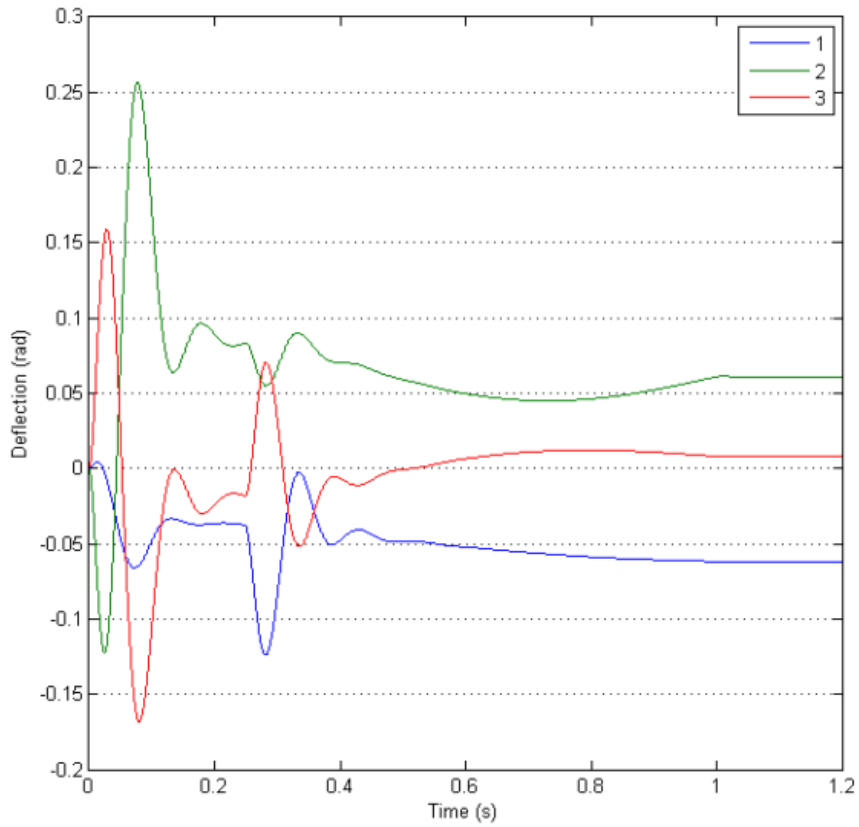

Figure 35 Deflections: 1) $\theta_1 - \phi_1$ 2) $\theta_3 - \phi_3$ 3) $\theta_5 - \phi_5$

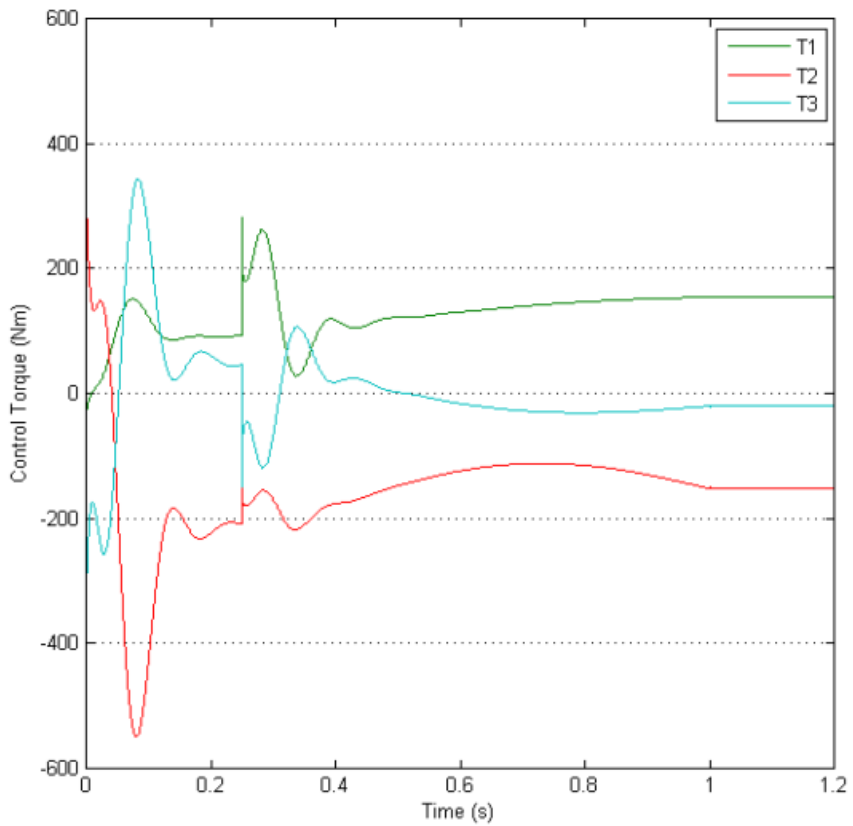

Figure 36 Control Torques

Case IV

- Impact ($t = 0.25$ s), 10% modeling error

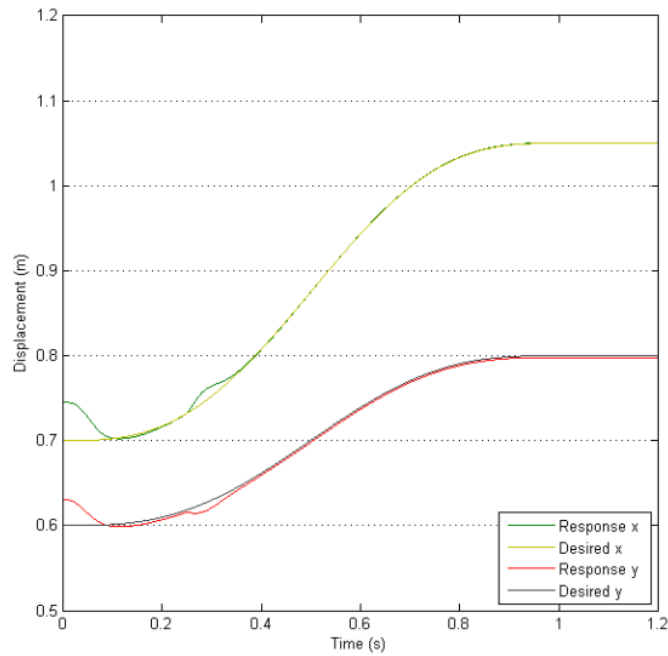

Figure 37 Position Response (x_G and y_G)

In Figure 37, $ess_{x_G} = 0.000014$ [m] and $ess_{y_G} = 0.002215$ [m]

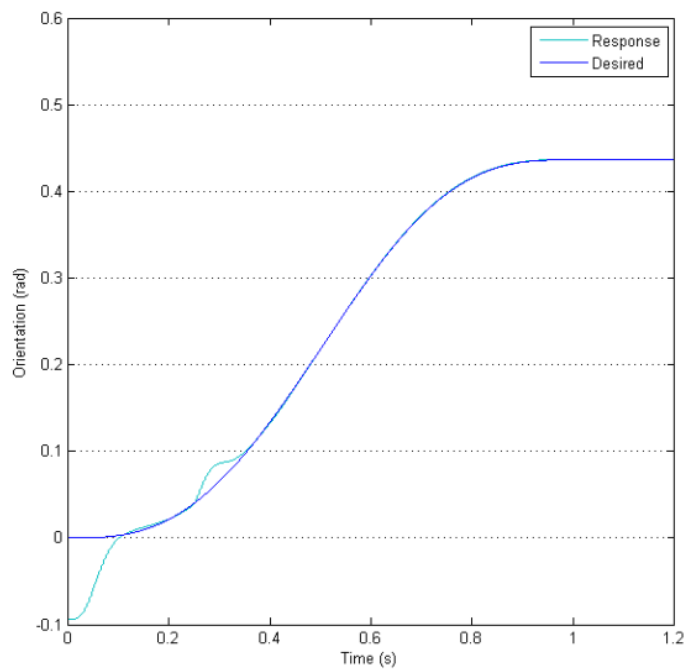

Figure 38 Position Response (θ_7)

In Figure 38, $ess_{\theta_7} = 0.0000007$ [rad]

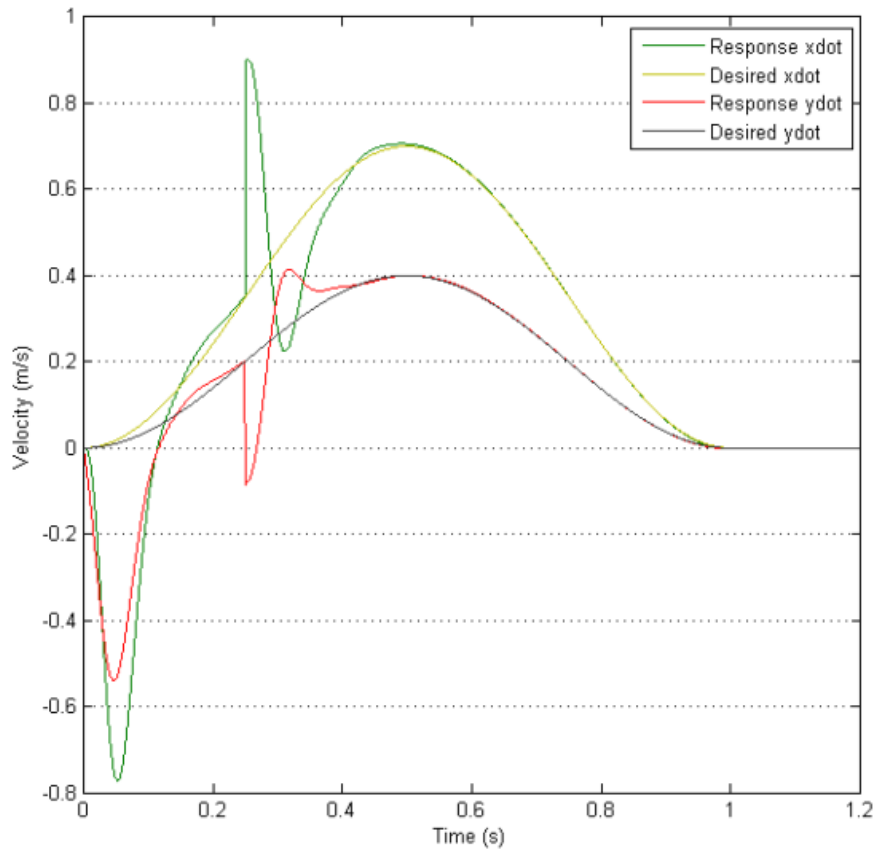

Figure 39 Velocity Response (\dot{x}_G and \dot{y}_G)

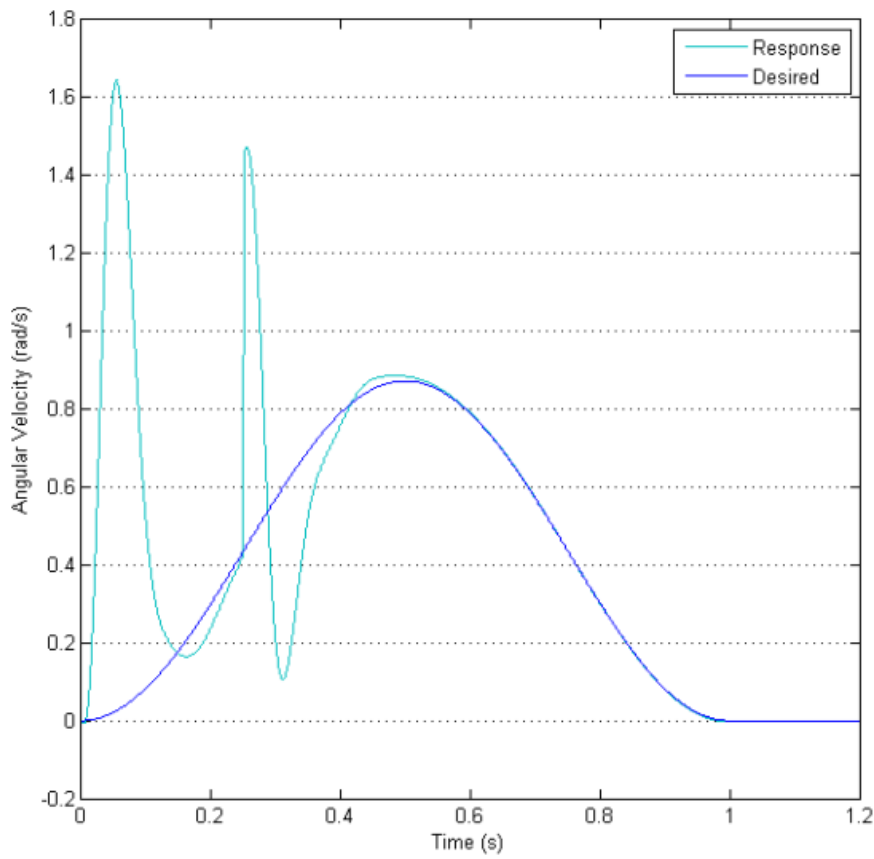

Figure 40 Velocity Response ($\dot{\theta}_7$)

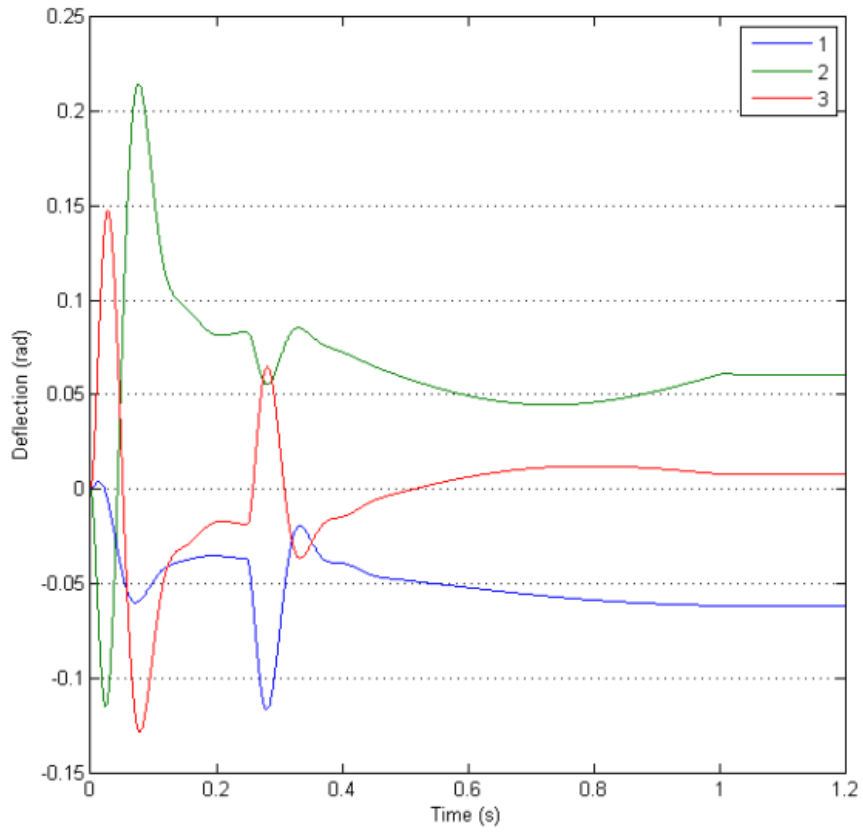

Figure 41 Deflections: 1) $\theta_1 - \phi_1$ 2) $\theta_3 - \phi_3$ 3) $\theta_5 - \phi_5$

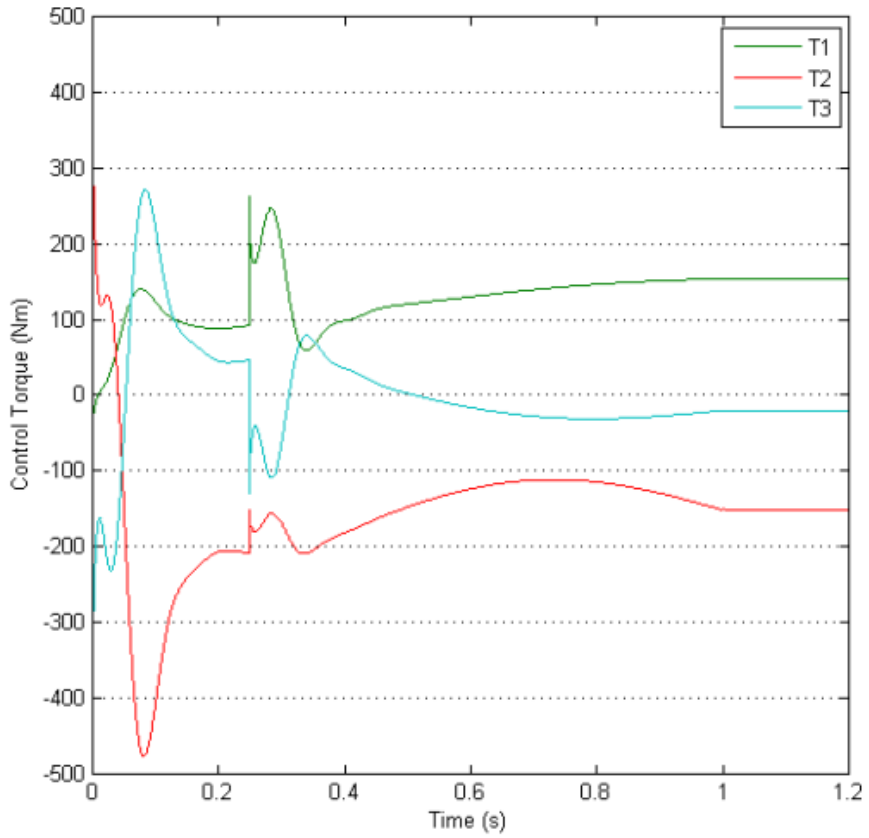

Figure 42 Control Torques

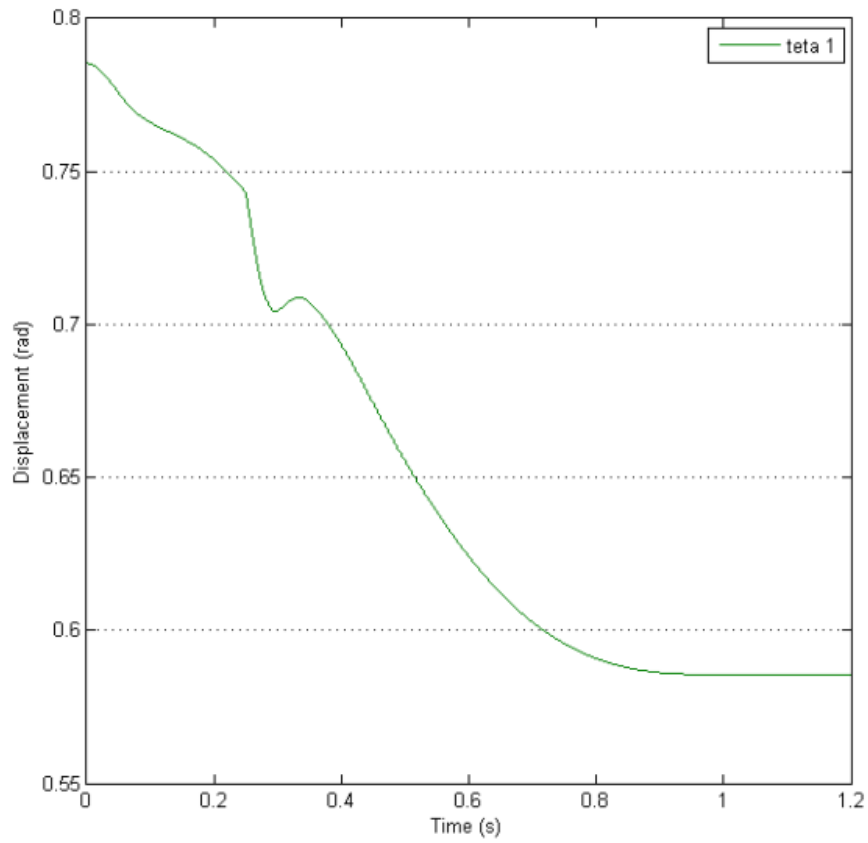

Figure 43 Position Response (θ_1)

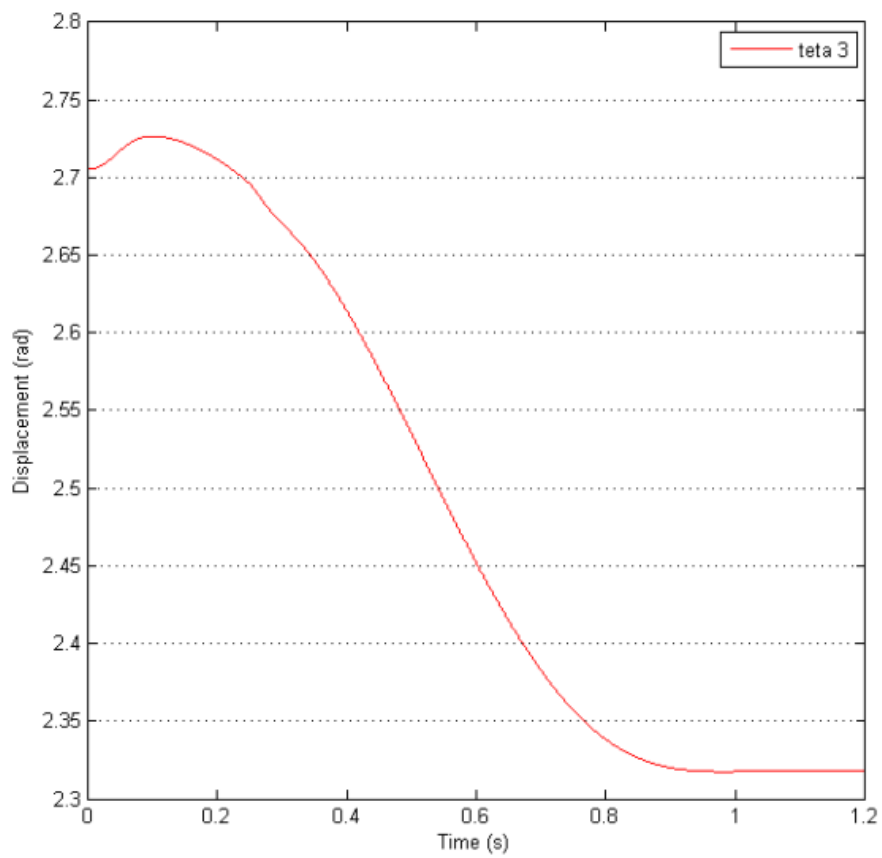

Figure 44 Position Response (θ_3)

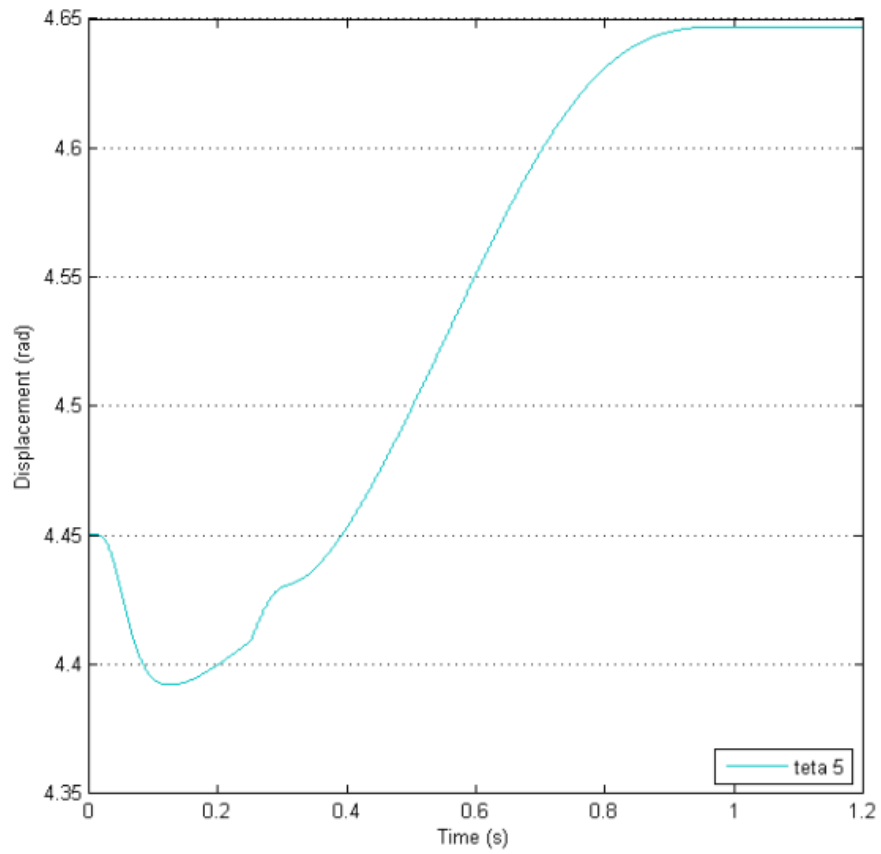

Figure 45 Position Response (θ_5)

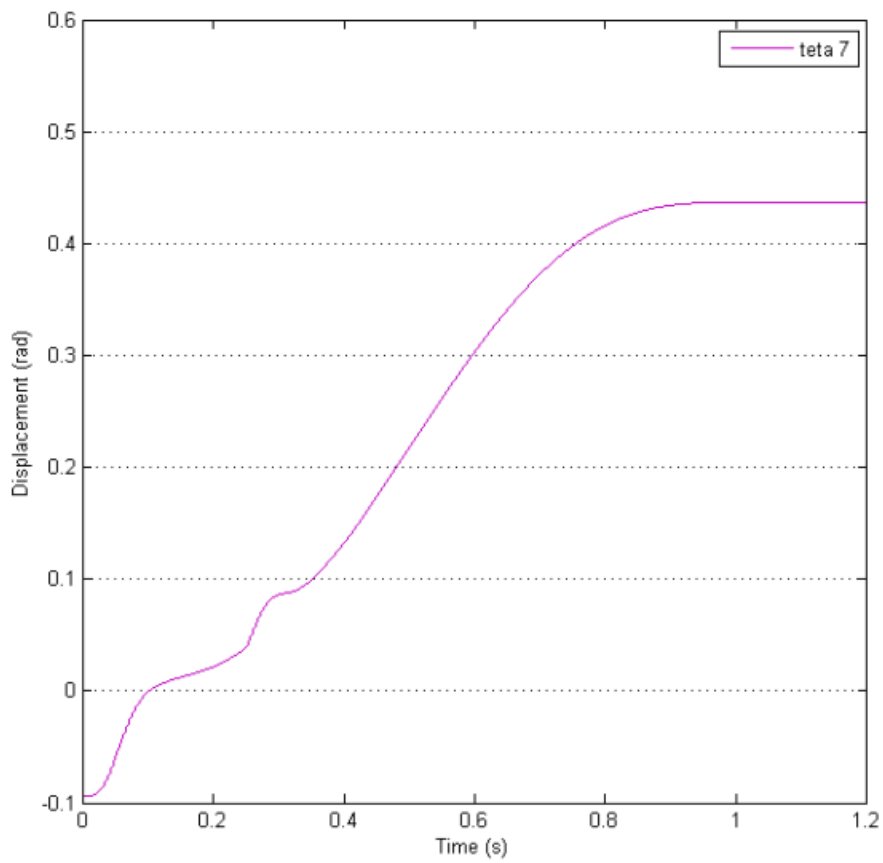

Figure 46 Position Response (θ_7)

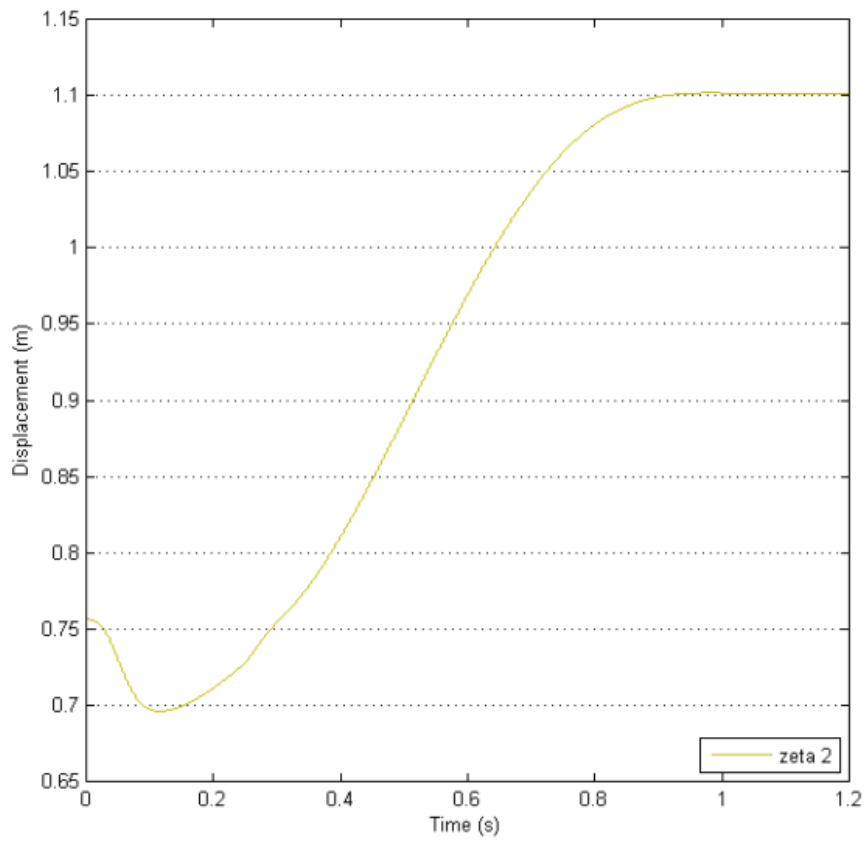

Figure 47 Position Response (ξ_2)

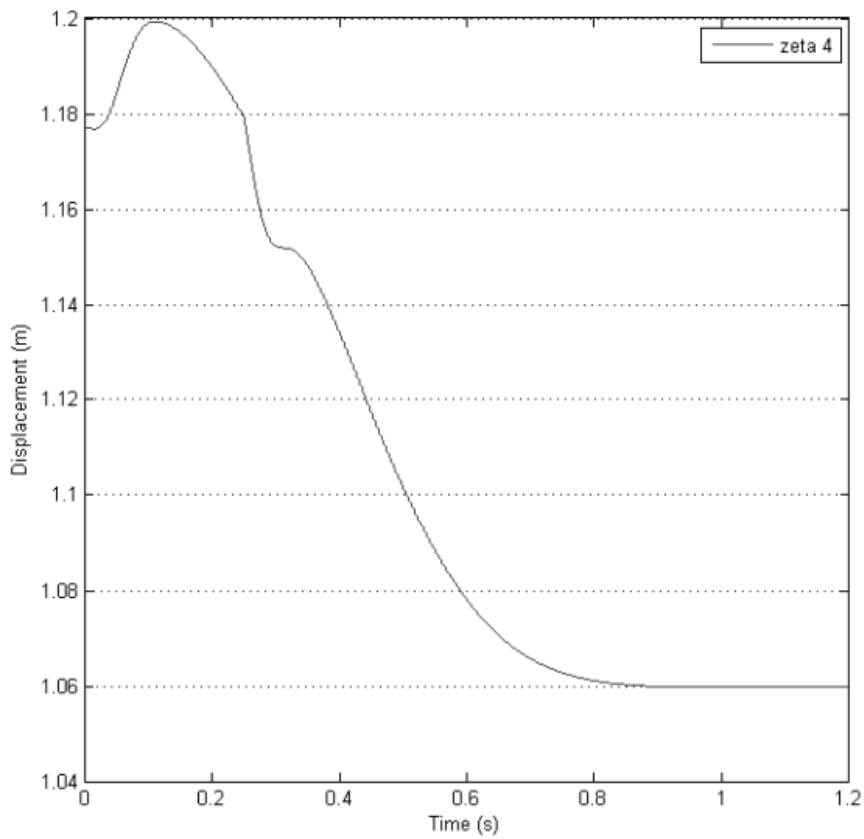

Figure 48 Position Response (ξ_4)

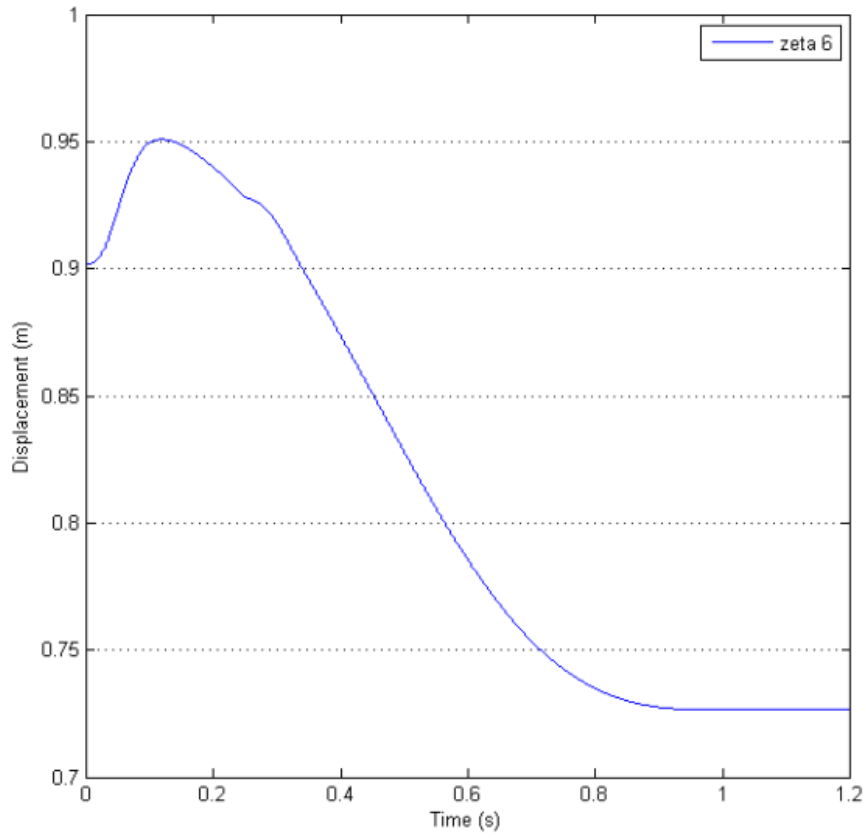

Figure 49 Position Response (ξ_6)

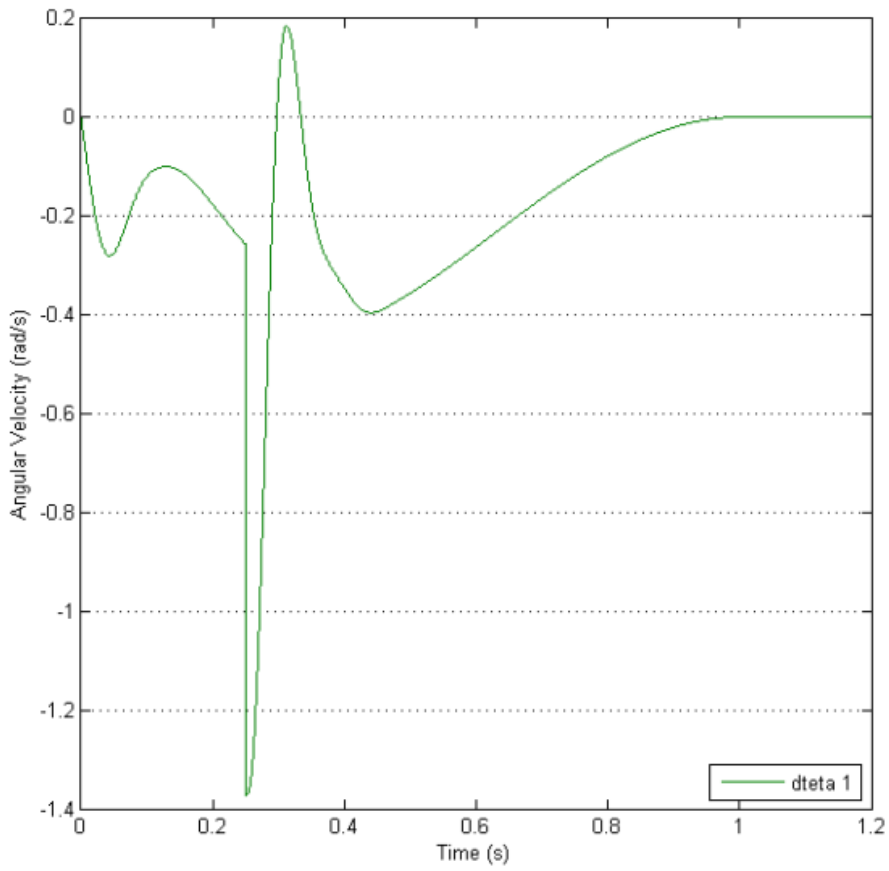

Figure 50 Velocity Response ($\dot{\theta}_1$)

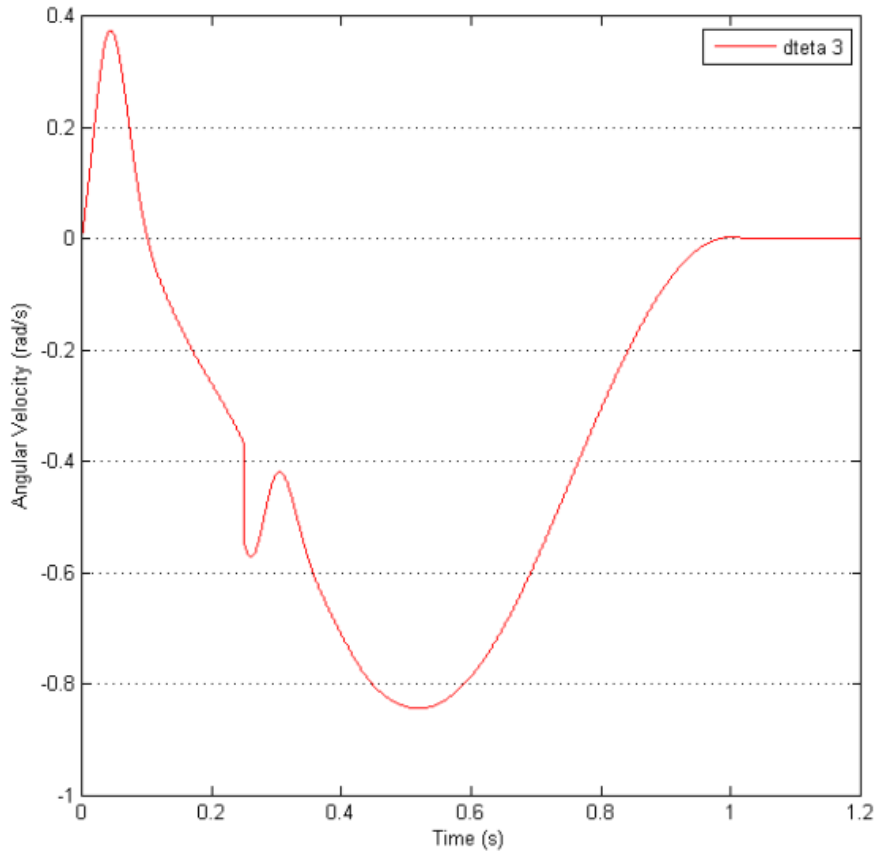

Figure 51 Velocity Response ($\dot{\theta}_3$)

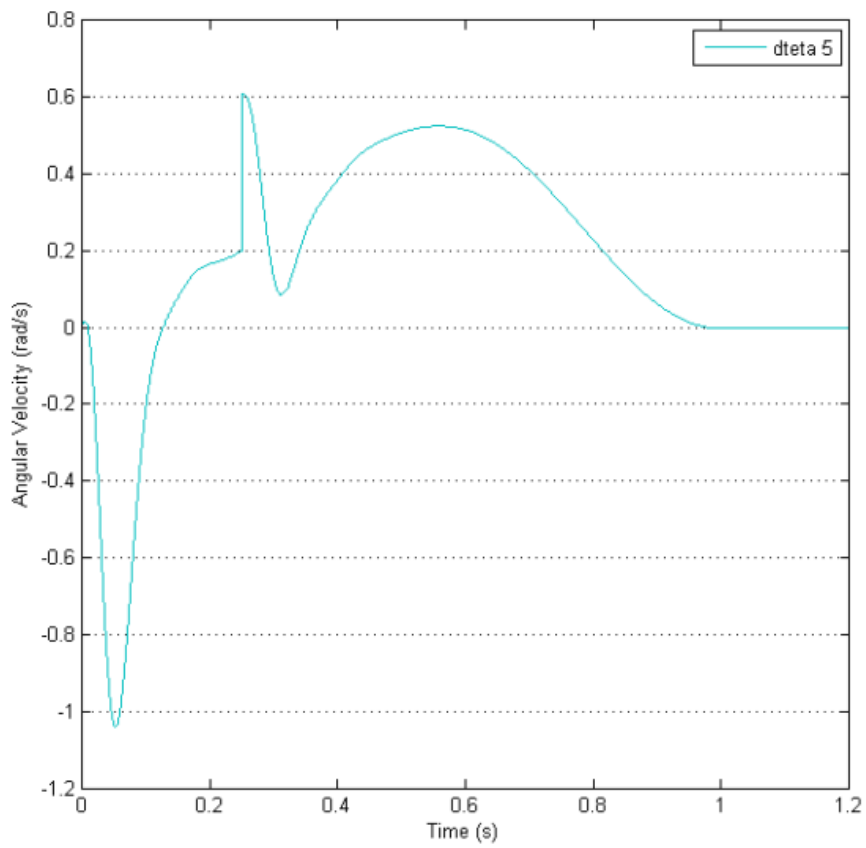

Figure 52 Velocity Response ($\dot{\theta}_5$)

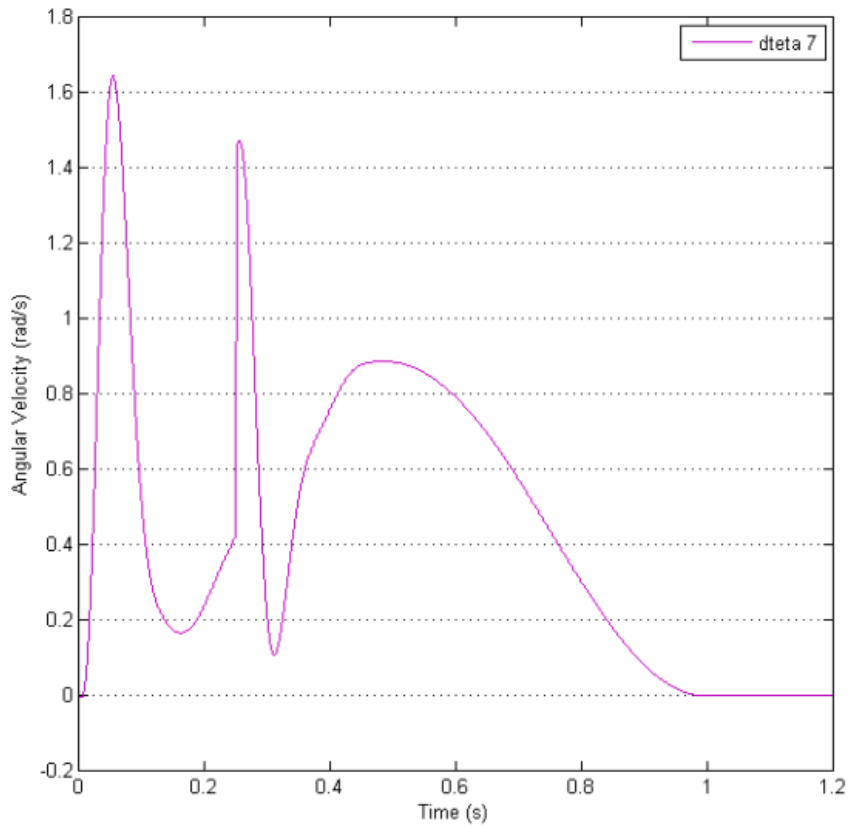

Figure 53 Velocity Response ($\dot{\theta}_7$)

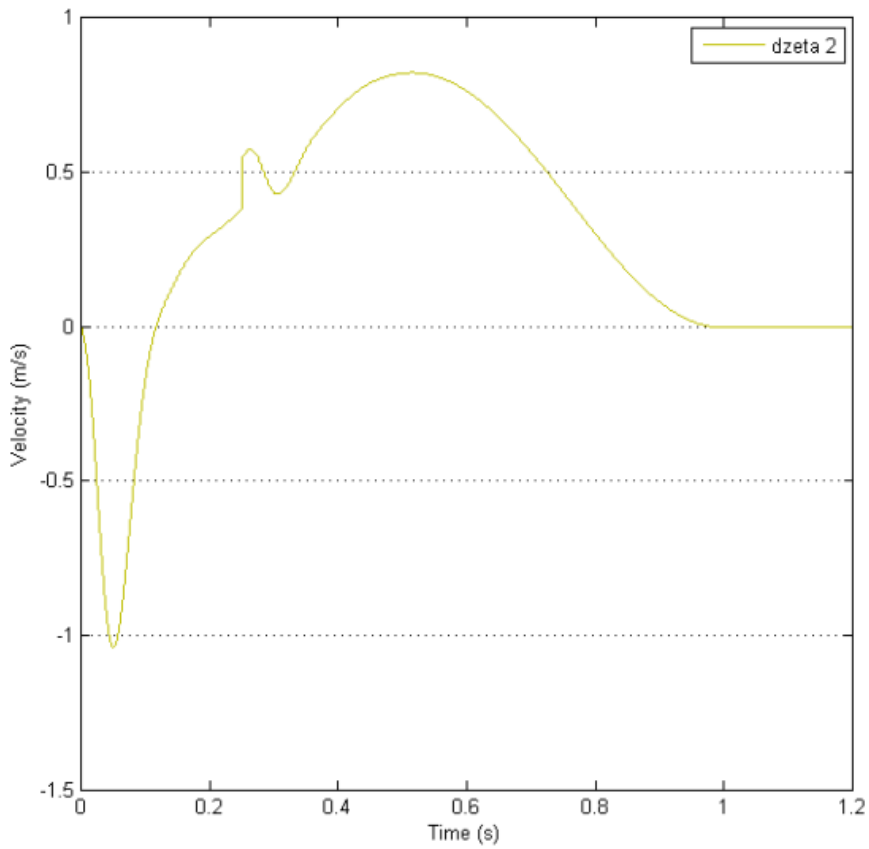

Figure 54 Velocity Response ($\dot{\xi}_2$)

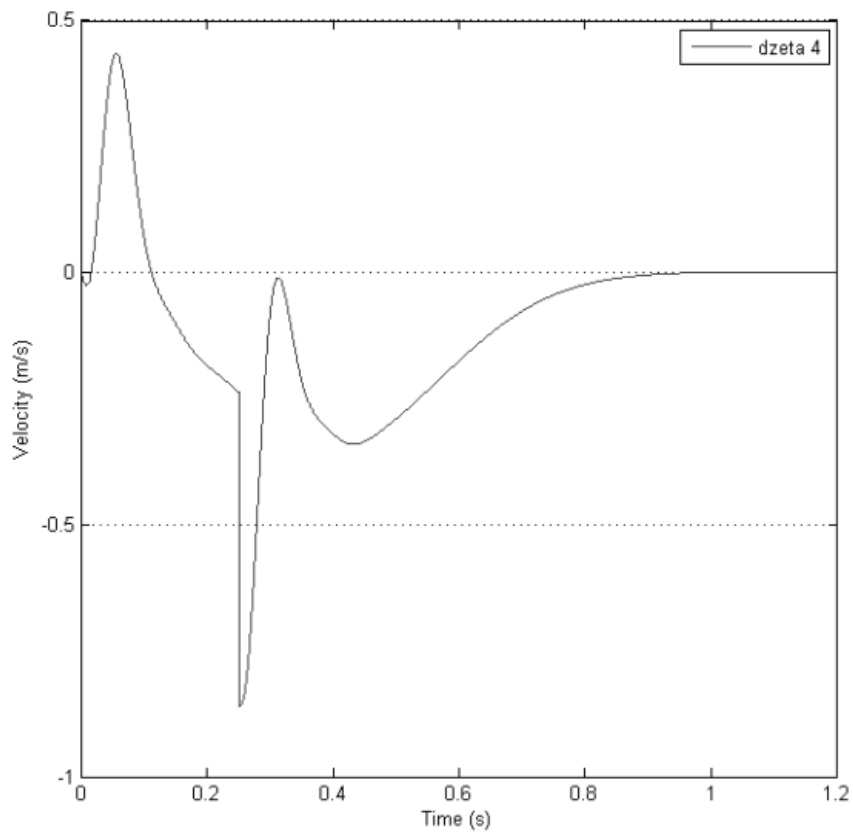

Figure 55 Velocity Response (ξ_4)

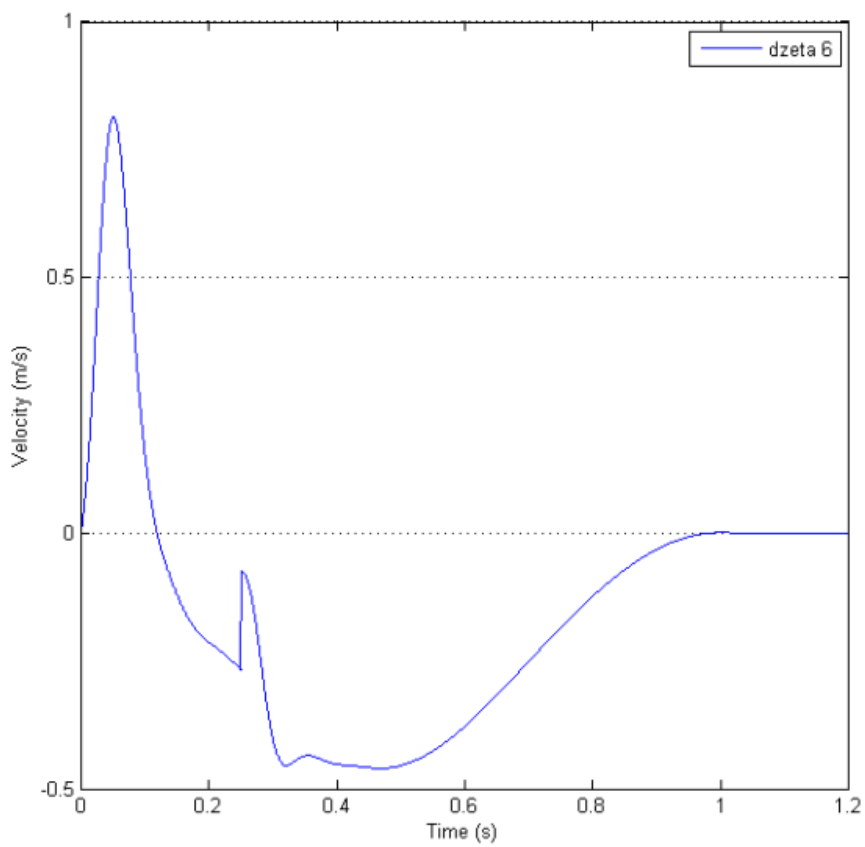

Figure 56 Velocity Response (ξ_6)

CHAPTER 5

CONCLUSION

In this study a flexible joint parallel robot is investigated when it is subjected to an impact. Dynamic equations and constraint equations are derived and system equations of motion are provided. The concept of coefficient of restitution is also presented and the governing system impulse-momentum equations are derived.

Inverse dynamics control method is examined and intermediate variables are eliminated to get an input/output relation. For checking the control law, a 3-RPR parallel manipulator with flexible joints subject to an impact is investigated. All of the scripts are written in Matlab[®] software program and the simulation model is created and performed in Simulink[®] which is one of the tools embedded in Matlab[®] program. Euler (Ode1) solver is used in the simulations with the fixed step-size. In the simulations initial position errors are applied to the system to check the performance.

During the simulation time, all of a sudden, a point mass body collides with the manipulator. The major assumption taken into consideration is coefficient of restitution is constant during the impact time which is too short and besides positions do not change during the impact time.

As it is seen in the results, impact has an instantaneous effect on end-effector velocity, joint variable velocity and torque values. Despite the instantaneous effect of the impact and the initial position error, satisfactory tracking performance is achieved and no instability is observed in the system. Steady state errors in Case II and Case IV are small.

For the future studies, different control methods can be applied to the system and the model mentioned through this study can be extended for spatial and other planar parallel robots.

WORKS CITED

1. **Lung-Wen, Tsai., (1999)**, “*Robot Analysis: The Mechanics of Serial and Parallel Manipulators*”, John Wiley & Sons, United States of America.
2. **Good M.C., Sweet L.M., Strobel K.L., (1985)**, “*Dynamic Models For Control System Design of Integrated Robot And Drive Systems*”, Journal of Dynamic Systems, Measurement and Control, Vol.107, pp.53-59.
3. **Spong M.W., (1987)**, “*Modeling and Control of Elastic Joint Robots*”, Journal of Dynamic Systems, Measurement and Control, Vol.109, pp.310-319.
4. **Forrest-Barlach M.G., Babcock S.M., (1987)**, “*Inverse Dynamics Position Control of a Complaint Manipulator*”, IEEE Journal of Robotics and Automation, No.1, Vol.Ra-3, pp.75-83.
5. **Jankowski K.P., Van Brussel H., (1992)**, “*An Approach to Discrete Inverse Dynamics Control of Flexible Joint Robots*”, IEEE Transactions on Robotics and Automation, No.5, Vol.8, pp.651-658.
6. **İder S.K., (2000)**, “*Force and Motion Trajectory Tracking Control of Flexible-Joint Robots*”, Mechanism and Machine Theory, Vol.35, pp.363-378.
7. **İder S.K. and Özgören M.K., (2000)**, “*Trajectory Tracking Control of Flexible-Joint Robots*”, Computers and Structures, Vol.76, pp.757-763.
8. **İder S.K. and Korkmaz O., (2009)**, “*Trajectory Tracking Control of Parallel Robots in the Presence of Joint Drive Flexibility*”, Journal of Sound and Vibration, Vol.319, pp.77-90.
9. **İder S.K., (2004)**, “*Singularity Robust Inverse Dynamics of Planar 2-RPR Parallel Manipulators*”, Proceedings of the Institution of Mechanical Engineers, Part C: Journal of Mechanical Engineering Science, No.7, Vol.218, pp.721-730.
10. **İder S.K. and Korkmaz O., (2014)**, “*Hybrid Force and Motion Control of Flexible Joint Parallel Manipulators Using Inverse Dynamics Approach*”, Advanced Robotics, 28:18, pp.1221-1230.
11. **Kılıçaslan S., (2015)**, “*Tracking Control of Elastic Joint Parallel Robots via State-Dependent Ricatti Equation*”, Turkish Journal of Electrical Engineering & Computer Sciences, Vol.23, pp.522-538.

12. **Haug E. and Wehage R.A., (1982)**, “*Dynamic Analysis of Mechanical Systems with Intermittent Motion*”, Journal of Mechanical Design, No.4, Vol.104, pp.778-784.
13. **İlkay Y.A., (1995)**, “*Modeling and Analysis of Impact in Flexible Multi-Body Systems*” M.S. Thesis, Mechanical Engineering Department, Middle East Technical University, Ankara, Turkey.
14. **Liu S., Lu Z., Wu L., (2007)**, “*Impact Dynamics and Control of a Flexible Dual-Arm Space Robot Capturing an Object*”, Applied Mathematics and Computation, Vol.185, pp.1149-1159.
15. **Gherman B., Suci M., Pislă D., Plitea N., Vaida C., (2013)**, “*An Active Hybrid Parallel Robot for Minimally Invasive Surgery*”, Robotics and Computer-Integrated Manufacturing, Vol.29, Issue 4, pp.203-221.
16. **Angeles J. and Zhang D.G., (2005)**, “*Impact Dynamics of Flexible-Joint Robots*”, Computers & Structures, Vol.83, pp.25-33.
17. **Qian Z. and Zhang D., (2012)**, “*Impact Dynamics of Multi-link Robots with Link and Joint Flexibility*”, Applied Mechanics and Materials, Vols.226-228, pp.686-692.
18. **Zhang L., Jia Q., Chen G., Sun H., Cao L., (2014)**, “*Impact Analysis of Space Manipulator Collision with Soft Environment*”, Industrial Electronics and Applications (ICIEA), 2014 IEEE 9th Conference, pp.1965-1970.
19. **Korkmaz O., (2006)**, “*Inverse Dynamics Control of Flexible Joint Parallel Manipulators*” M.S. Thesis, Mechanical Engineering Department, Middle East University, Ankara, Turkey.
20. **Selvi Ö., (2015)**, “ME536 Advanced Robotics Lecture Notes”, Mechanical Engineering Department, Çankaya University, Ankara, Turkey.
21. “Simulink-Simulation and Model-Based Design” *Mathworks*. Accessed January 24, 2016.
<http://www.mathworks.com/products/simulink/?requestedDomain=www.mathworks.com>

APPENDIX

TIME DERIVATIVES OF MATRICES

1. The First and Second Time Derivatives of \widehat{M}

$$\dot{M}_{11} = 2m_2\dot{\xi}_2(\xi_2 - a_2) + 2m_7\dot{\xi}_2\xi_2$$

$$\dot{M}_{12} = 0$$

$$\dot{M}_{13} = 0$$

$$\dot{M}_{14} = m_7\dot{\xi}_2g_7 \cos(\theta_1 - \theta_7 - \beta) - m_7\xi_2g_7 \sin(\theta_1 - \theta_7 - \beta)(\dot{\theta}_1 - \dot{\theta}_7)$$

$$\dot{M}_{15} = 0$$

$$\dot{M}_{16} = 0$$

$$\dot{M}_{17} = 0$$

$$\dot{M}_{21} = 0$$

$$\dot{M}_{22} = 2m_4\dot{\xi}_4(\xi_4 - a_4)$$

$$\dot{M}_{23} = 0$$

$$\dot{M}_{24} = 0$$

$$\dot{M}_{25} = 0$$

$$\dot{M}_{26} = 0$$

$$\dot{M}_{27} = 0$$

$$\dot{M}_{31} = 0$$

$$\dot{M}_{32} = 0$$

$$\dot{M}_{33} = 2m_6\dot{\xi}_6(\xi_6 - a_6)$$

$$\dot{M}_{34} = 0$$

$$\dot{M}_{35} = 0$$

$$\dot{M}_{36} = 0$$

$$\dot{M}_{37} = 0$$

$$\dot{M}_{41} = m_7\dot{\xi}_2g_7 \cos(\theta_1 - \theta_7 - \beta) - m_7\xi_2g_7 \sin(\theta_1 - \theta_7 - \beta)(\dot{\theta}_1 - \dot{\theta}_7)$$

$$\dot{M}_{42} = 0$$

$$\dot{M}_{43} = 0$$

$$\dot{M}_{44} = 0$$

$$\dot{M}_{45} = m_7 \xi_2 g_7 \sin(\theta_1 - \theta_7 - \beta)(\dot{\theta}_1 - \dot{\theta}_7)$$

$$\dot{M}_{46} = 0$$

$$\dot{M}_{47} = 0$$

$$\dot{M}_{51} = 0$$

$$\dot{M}_{52} = 0$$

$$\dot{M}_{53} = 0$$

$$\dot{M}_{54} = m_7 \xi_2 g_7 \sin(\theta_1 - \theta_7 - \beta)(\dot{\theta}_1 - \dot{\theta}_7)$$

$$\dot{M}_{55} = 0$$

$$\dot{M}_{56} = 0$$

$$\dot{M}_{57} = 0$$

$$\dot{M}_{61} = 0$$

$$\dot{M}_{62} = 0$$

$$\dot{M}_{63} = 0$$

$$\dot{M}_{64} = 0$$

$$\dot{M}_{65} = 0$$

$$\dot{M}_{66} = 0$$

$$\dot{M}_{67} = 0$$

$$\dot{M}_{71} = 0$$

$$\dot{M}_{72} = 0$$

$$\dot{M}_{73} = 0$$

$$\dot{M}_{74} = 0$$

$$\dot{M}_{75} = 0$$

$$\dot{M}_{76} = 0$$

$$\dot{M}_{77} = 0$$

$$\dot{M}_{11} = 2m_2 \ddot{\xi}_2 (\xi_2 - a_2) + 2m_2 \dot{\xi}_2^2 + 2m_7 \ddot{\xi}_2 \xi_2 + 2m_7 \dot{\xi}_2^2$$

$$\dot{M}_{12} = 0$$

$$\dot{M}_{13} = 0$$

$$\begin{aligned} \dot{M}_{14} = & m_7 \ddot{\xi}_2 g_7 \cos(\theta_1 - \theta_7 - \beta) - 2m_7 \dot{\xi}_2 g_7 \sin(\theta_1 - \theta_7 - \beta) (\dot{\theta}_1 - \dot{\theta}_7) \\ & - m_7 \xi_2 g_7 \cos(\theta_1 - \theta_7 - \beta) (\dot{\theta}_1 - \dot{\theta}_7)^2 - m_7 \xi_2 g_7 \sin(\theta_1 - \theta_7 - \beta) (\ddot{\theta}_1 \\ & - \ddot{\theta}_7) \end{aligned}$$

$$\dot{M}_{15} = 0$$

$$\dot{M}_{16} = 0$$

$$\dot{M}_{17} = 0$$

$$\dot{M}_{21} = 0$$

$$\dot{M}_{22} = 2m_4\ddot{\xi}_4(\xi_4 - a_4) + 2m_4\dot{\xi}_4^2$$

$$\dot{M}_{23} = 0$$

$$\dot{M}_{24} = 0$$

$$\dot{M}_{25} = 0$$

$$\dot{M}_{26} = 0$$

$$\dot{M}_{27} = 0$$

$$\dot{M}_{31} = 0$$

$$\dot{M}_{32} = 0$$

$$\dot{M}_{33} = 2m_6\ddot{\xi}_6(\xi_6 - a_6) + 2m_6\dot{\xi}_6^2$$

$$\dot{M}_{34} = 0$$

$$\dot{M}_{35} = 0$$

$$\dot{M}_{36} = 0$$

$$\dot{M}_{37} = 0$$

$$\begin{aligned}\dot{M}_{41} = & m_7\ddot{\xi}_2g_7 \cos(\theta_1 - \theta_7 - \beta) - 2m_7\dot{\xi}_2g_7 \sin(\theta_1 - \theta_7 - \beta) (\dot{\theta}_1 - \dot{\theta}_7) \\ & - m_7\dot{\xi}_2g_7 \cos(\theta_1 - \theta_7 - \beta) (\dot{\theta}_1 - \dot{\theta}_7)^2 - m_7\dot{\xi}_2g_7 \sin(\theta_1 - \theta_7 - \beta) (\ddot{\theta}_1 \\ & - \ddot{\theta}_7)\end{aligned}$$

$$\dot{M}_{42} = 0$$

$$\dot{M}_{43} = 0$$

$$\dot{M}_{44} = 0$$

$$\dot{M}_{45} = -m_7g_7 \sin(\theta_1 - \theta_7 - \beta) (\dot{\theta}_1 - \dot{\theta}_7)^2 + m_7g_7 \cos(\theta_1 - \theta_7 - \beta) (\ddot{\theta}_1 - \ddot{\theta}_7)$$

$$\dot{M}_{46} = 0$$

$$\dot{M}_{47} = 0$$

$$\dot{M}_{51} = 0$$

$$\dot{M}_{52} = 0$$

$$\dot{M}_{53} = 0$$

$$\dot{M}_{54} = -m_7g_7 \sin(\theta_1 - \theta_7 - \beta) (\dot{\theta}_1 - \dot{\theta}_7)^2 + m_7g_7 \cos(\theta_1 - \theta_7 - \beta) (\ddot{\theta}_1 - \ddot{\theta}_7)$$

$$\dot{M}_{55} = 0$$

$$\dot{M}_{56} = 0$$

$$\dot{M}_{57} = 0$$

$$\dot{M}_{61} = 0$$

$$\dot{M}_{62} = 0$$

$$\dot{M}_{63} = 0$$

$$\dot{M}_{64} = 0$$

$$\dot{M}_{65} = 0$$

$$\dot{M}_{66} = 0$$

$$\dot{M}_{67} = 0$$

$$\dot{M}_{71} = 0$$

$$\dot{M}_{72} = 0$$

$$\dot{M}_{73} = 0$$

$$\dot{M}_{74} = 0$$

$$\dot{M}_{75} = 0$$

$$\dot{M}_{76} = 0$$

$$\dot{M}_{77} = 0$$

2. The First and Second Time Derivatives of \vec{Q}

$$\begin{aligned}\dot{Q}_1 &= 2m_2\dot{\xi}_2^2\dot{\theta}_1 + 2m_2(\xi_2 - a_2)\ddot{\xi}_2\dot{\theta}_1 + 2m_2(\xi_2 - a_2)\dot{\xi}_2\ddot{\theta}_1 + 2m_7\dot{\xi}_2\ddot{\xi}_2\dot{\theta}_1 + 2m_7\dot{\xi}_2^2\dot{\theta}_1 \\ &\quad + 2m_7\dot{\xi}_2\dot{\xi}_2\ddot{\theta}_1 + m_7\dot{\xi}_2\dot{\theta}_7^2g_7\sin(\theta_1 - \theta_7 - \beta) \\ &\quad + 2m_7\dot{\xi}_2\dot{\theta}_7\ddot{\theta}_7g_7\sin(\theta_1 - \theta_7 - \beta) + m_7\dot{\xi}_2\dot{\theta}_7^2g_7\cos(\theta_1 - \theta_7 - \beta)(\dot{\theta}_1 - \dot{\theta}_7) \\ &\quad - m_1ga_1\dot{\theta}_1\sin(\theta_1) \\ &\quad + m_2g\dot{\xi}_2\cos(\theta_1) - m_2g\dot{\theta}_1(\xi_2 - a_2)\sin(\theta_1) + m_7g\dot{\xi}_2\cos(\theta_1) \\ &\quad - m_7g\dot{\xi}_2\dot{\theta}_1\sin(\theta_1)\end{aligned}$$

$$\begin{aligned}\dot{Q}_2 &= 2m_4\dot{\xi}_4^2\dot{\theta}_3 + 2m_4(\xi_4 - a_4)\ddot{\xi}_4\dot{\theta}_3 + 2m_4(\xi_4 - a_4)\dot{\xi}_4\ddot{\theta}_3 \\ &\quad - m_3ga_3\dot{\theta}_3\sin(\theta_3) + m_4g\dot{\xi}_4\cos(\theta_3) - m_4g(\xi_4 - a_4)\dot{\theta}_3\sin(\theta_3)\end{aligned}$$

$$\begin{aligned}\dot{Q}_3 &= 2m_6\dot{\xi}_6^2\dot{\theta}_5 + 2m_6(\xi_6 - a_6)\ddot{\xi}_6\dot{\theta}_5 + 2m_6(\xi_6 - a_6)\dot{\xi}_6\ddot{\theta}_5 \\ &\quad - m_5ga_5\dot{\theta}_5\sin(\theta_5) + m_6g\dot{\xi}_6\cos(\theta_5) - m_6g(\xi_6 - a_6)\dot{\theta}_5\sin(\theta_5)\end{aligned}$$

$$\begin{aligned}
\dot{Q}_4 = & 2m_7\ddot{\xi}_2\dot{\theta}_1g_7 \cos(\theta_1 - \theta_7 - \beta) + 2m_7\dot{\xi}_2\ddot{\theta}_1g_7 \cos(\theta_1 - \theta_7 - \beta) \\
& - 2m_7\dot{\xi}_2\dot{\theta}_1g_7 \sin(\theta_1 - \theta_7 - \beta) (\dot{\theta}_1 - \dot{\theta}_7) - 2m_7\ddot{\xi}_2\dot{\theta}_7g_7 \cos(\theta_1 - \theta_7 - \beta) \\
& - 2m_7\dot{\xi}_2\ddot{\theta}_7g_7 \cos(\theta_1 - \theta_7 - \beta) + 2m_7\dot{\xi}_2\dot{\theta}_7g_7 \sin(\theta_1 - \theta_7 - \beta) (\dot{\theta}_1 - \dot{\theta}_7) \\
& + 2m_7\dot{\xi}_2\dot{\theta}_1\dot{\theta}_7g_7 \sin(\theta_1 - \theta_7 - \beta) + 2m_7\dot{\xi}_2\ddot{\theta}_1\dot{\theta}_7g_7 \sin(\theta_1 - \theta_7 - \beta) \\
& + 2m_7\dot{\xi}_2\dot{\theta}_1\ddot{\theta}_7g_7 \sin(\theta_1 - \theta_7 - \beta) \\
& + 2m_7\dot{\xi}_2\dot{\theta}_1\dot{\theta}_7g_7 \cos(\theta_1 - \theta_7 - \beta)(\dot{\theta}_1 - \dot{\theta}_7) - m_7\dot{\xi}_2\dot{\theta}_1^2g_7 \sin(\theta_1 - \theta_7 - \beta) \\
& - 2m_7\dot{\xi}_2\dot{\theta}_1\ddot{\theta}_1g_7 \sin(\theta_1 - \theta_7 - \beta) - m_7\dot{\xi}_2\dot{\theta}_1^2 \cos(\theta_1 - \theta_7 - \beta)(\dot{\theta}_1 - \dot{\theta}_7) \\
& - m_7g_7\sin(\theta_7 + \beta)\dot{\theta}_7 \\
\dot{Q}_5 = & -2m_7\dot{\theta}_7\ddot{\theta}_7g_7 \cos(\theta_1 - \theta_7 - \beta) + m_7\dot{\theta}_7^2g_7 \sin(\theta_1 - \theta_7 - \beta) (\dot{\theta}_1 - \dot{\theta}_7) - m_2\dot{\xi}_2\dot{\theta}_1^2 \\
& - 2m_2(\xi_2 - a_2)\dot{\theta}_1\ddot{\theta}_1 - m_7\dot{\xi}_2\dot{\theta}_1^2 - 2m_7\dot{\xi}_2\dot{\theta}_1\ddot{\theta}_1 + m_2g\dot{\theta}_1 \cos(\theta_1) \\
& + m_7g\dot{\theta}_1 \cos(\theta_1) \\
\dot{Q}_6 = & -m_4\dot{\xi}_4\dot{\theta}_3^2 - 2m_4(\xi_4 - a_4)\dot{\theta}_3\ddot{\theta}_3 + m_4g\dot{\theta}_3 \cos(\theta_3) \\
\dot{Q}_7 = & -m_6\dot{\xi}_6\dot{\theta}_5^2 - 2m_6(\xi_6 - a_6)\dot{\theta}_5\ddot{\theta}_5 + m_6g\dot{\theta}_5 \cos(\theta_5) \\
\ddot{Q}_1 = & 4m_2\dot{\xi}_2\ddot{\xi}_2\dot{\theta}_1 + 4m_2\dot{\xi}_2^2\ddot{\theta}_1 + 2m_2\dot{\xi}_2\ddot{\xi}_2\dot{\theta}_1 + 2m_2(\xi_2 - a_2)\ddot{\xi}_2\dot{\theta}_1 + 4m_2(\xi_2 - a_2)\ddot{\xi}_2\ddot{\theta}_1 \\
& + 2m_2(\xi_2 - a_2)\dot{\xi}_2\ddot{\theta}_1 + 2m_7\ddot{\xi}_2\dot{\xi}_2\dot{\theta}_1 + 2m_7\dot{\xi}_2\ddot{\xi}_2\dot{\theta}_1 + 4m_7\dot{\xi}_2\ddot{\xi}_2\dot{\theta}_1 + 4m_7\dot{\xi}_2^2\ddot{\theta}_1 \\
& + 4m_7\ddot{\xi}_2\dot{\xi}_2\ddot{\theta}_1 + 2m_7\dot{\xi}_2\dot{\xi}_2\ddot{\theta}_1 + m_7\dot{\xi}_2\dot{\theta}_7^2g_7 \sin(\theta_1 - \theta_7 - \beta) \\
& + 2m_7\dot{\xi}_2\dot{\theta}_7^2g_7 \cos(\theta_1 - \theta_7 - \beta)(\dot{\theta}_1 - \dot{\theta}_7) + 4m_7\dot{\xi}_2\dot{\theta}_7\ddot{\theta}_7g_7 \sin(\theta_1 - \theta_7 - \beta) \\
& + 2m_7\dot{\xi}_2\ddot{\theta}_7^2g_7 \sin(\theta_1 - \theta_7 - \beta) + 2m_7\dot{\xi}_2\dot{\theta}_7\ddot{\theta}_7g_7 \sin(\theta_1 - \theta_7 - \beta) \\
& + 4m_7\dot{\xi}_2\dot{\theta}_7\ddot{\theta}_7 \cos(\theta_1 - \theta_7 - \beta)(\dot{\theta}_1 - \dot{\theta}_7) \\
& - m_7\dot{\xi}_2\dot{\theta}_7^2g_7 \sin(\theta_1 - \theta_7 - \beta) (\dot{\theta}_1 - \dot{\theta}_7)^2 \\
& + m_7\dot{\xi}_2\dot{\theta}_7^2 \cos(\theta_1 - \theta_7 - \beta) (\ddot{\theta}_1 - \ddot{\theta}_7) - m_1ga_1\ddot{\theta}_1 \sin(\theta_1) \\
& - m_1ga_1\dot{\theta}_1^2 \cos(\theta_1) + m_2g \dot{\xi}_2 \cos(\theta_1) - 2m_2g\dot{\xi}_2\dot{\theta}_1 \sin(\theta_1) \\
& - m_2g\ddot{\theta}_1(\xi_2 - a_2) \sin(\theta_1) - m_2g\dot{\theta}_1^2(\xi_2 - a_2) \cos(\theta_1) + m_7g\dot{\xi}_2 \cos(\theta_1) \\
& - 2m_7g\dot{\xi}_2\dot{\theta}_1 \sin(\theta_1) - m_7g\dot{\xi}_2\ddot{\theta}_1 \sin(\theta_1) - m_7g\dot{\xi}_2\dot{\theta}_1^2 \cos(\theta_1) \\
\ddot{Q}_2 = & 4m_4\dot{\xi}_4\ddot{\xi}_4\dot{\theta}_3 + 2m_4\dot{\xi}_4\dot{\xi}_4\ddot{\theta}_3 + 2m_4(\xi_4 - a_4)\ddot{\xi}_4\dot{\theta}_3 + 4m_4\dot{\xi}_4^2\ddot{\theta}_3 + 4m_4(\xi_4 - a_4)\dot{\xi}_4\ddot{\theta}_3 \\
& + 2m_4(\xi_4 - a_4)\dot{\xi}_4\ddot{\theta}_3 - m_3ga_3\ddot{\theta}_3 \sin(\theta_3) - m_3ga_3\dot{\theta}_3^2 \cos(\theta_3) \\
& + m_4g\dot{\xi}_4 \cos(\theta_3) - 2m_4g\dot{\xi}_4\dot{\theta}_3 \sin(\theta_3) - m_4g(\xi_4 - a_4)\ddot{\theta}_3 \sin(\theta_3) \\
& - m_4g(\xi_4 - a_4)\dot{\theta}_3^2 \cos(\theta_3)
\end{aligned}$$

$$\begin{aligned}
\ddot{Q}_3 = & 4m_6\dot{\xi}_6\ddot{\xi}_6\dot{\theta}_5 + 2m_6\dot{\xi}_6\ddot{\xi}_6\dot{\theta}_5 + 2m_6(\xi_6 - a_6)\ddot{\xi}_6\dot{\theta}_5 + 4m_6\dot{\xi}_6^2\ddot{\theta}_5 + 4m_6(\xi_6 - a_6)\dot{\xi}_6\ddot{\theta}_5 \\
& + 2m_6(\xi_6 - a_6)\dot{\xi}_6\ddot{\theta}_5 - m_5ga_5\ddot{\theta}_3 \sin(\theta_5) - m_5ga_5\dot{\theta}_5^2 \cos(\theta_5) \\
& + m_6g\dot{\xi}_6 \cos(\theta_5) - 2m_6g\dot{\xi}_6\dot{\theta}_5 \sin(\theta_5) - m_6g(\xi_6 - a_6)\ddot{\theta}_5 \sin(\theta_5) \\
& - m_6g(\xi_6 - a_6)\dot{\theta}_5^2 \cos(\theta_5)
\end{aligned}$$

$$\begin{aligned}
\ddot{Q}_4 = & 2m_7\ddot{\xi}_2\dot{\theta}_1g_7 \cos(\theta_1 - \theta_7 - \beta) + 4m_7\dot{\xi}_2\ddot{\theta}_1g_7 \cos(\theta_1 - \theta_7 - \beta) \\
& + 2m_7\dot{\xi}_2\ddot{\theta}_1g_7 \cos(\theta_1 - \theta_7 - \beta) - 4m_7\dot{\xi}_2\ddot{\theta}_1g_7 \sin(\theta_1 - \theta_7 - \beta) (\dot{\theta}_1 - \dot{\theta}_7) \\
& - 4m_7\dot{\xi}_2\dot{\theta}_1g_7 \sin(\theta_1 - \theta_7 - \beta) (\dot{\theta}_1 - \dot{\theta}_7) \\
& - 2m_7\dot{\xi}_2\dot{\theta}_1g_7 \cos(\theta_1 - \theta_7 - \beta) (\dot{\theta}_1 - \dot{\theta}_7)^2 \\
& - 2m_7\dot{\xi}_2\dot{\theta}_1 \sin(\theta_1 - \theta_7 - \beta) (\ddot{\theta}_1 - \ddot{\theta}_7) - 2m_7\dot{\xi}_2\dot{\theta}_7g_7 \cos(\theta_1 - \theta_7 - \beta) \\
& - 4m_7\dot{\xi}_2\ddot{\theta}_7g_7 \cos(\theta_1 - \theta_7 - \beta) - 2m_7\dot{\xi}_2\ddot{\theta}_7g_7 \cos(\theta_1 - \theta_7 - \beta) \\
& + 4m_7\dot{\xi}_2\ddot{\theta}_7g_7 \sin(\theta_1 - \theta_7 - \beta) (\dot{\theta}_1 - \dot{\theta}_7) \\
& + 4m_7\dot{\xi}_2\dot{\theta}_7g_7 \sin(\theta_1 - \theta_7 - \beta) (\dot{\theta}_1 - \dot{\theta}_7) \\
& + 2m_7\dot{\xi}_2\dot{\theta}_7g_7 \cos(\theta_1 - \theta_7 - \beta) (\dot{\theta}_1 - \dot{\theta}_7)^2 \\
& + 2m_7\dot{\xi}_2\dot{\theta}_7g_7 \sin(\theta_1 - \theta_7 - \beta) (\ddot{\theta}_1 - \ddot{\theta}_7) \\
& + 2m_7\dot{\xi}_2\dot{\theta}_1\dot{\theta}_7g_7 \sin(\theta_1 - \theta_7 - \beta) + 4m_7\dot{\xi}_2\ddot{\theta}_1\dot{\theta}_7g_7 \sin(\theta_1 - \theta_7 - \beta) \\
& + 2m_7\dot{\xi}_2\ddot{\theta}_1\dot{\theta}_7g_7 \cos(\theta_1 - \theta_7 - \beta) + 4m_7\dot{\xi}_2\ddot{\theta}_1\ddot{\theta}_7g_7 \sin(\theta_1 - \theta_7 - \beta) \\
& + 4m_7\dot{\xi}_2\dot{\theta}_1\ddot{\theta}_7g_7 \sin(\theta_1 - \theta_7 - \beta) + 2m_7\dot{\xi}_2\ddot{\theta}_7\dot{\theta}_1g_7 \sin(\theta_1 - \theta_7 - \beta) \\
& + 4m_7\dot{\xi}_2\dot{\theta}_1\dot{\theta}_7g_7 \cos(\theta_1 - \theta_7 - \beta) (\dot{\theta}_1 - \dot{\theta}_7) \\
& + 4m_7\dot{\xi}_2\ddot{\theta}_1\dot{\theta}_7g_7 \cos(\theta_1 - \theta_7 - \beta) (\dot{\theta}_1 - \dot{\theta}_7) \\
& + 4m_7\dot{\xi}_2\dot{\theta}_1\ddot{\theta}_7g_7 \cos(\theta_1 - \theta_7 - \beta) (\dot{\theta}_1 - \dot{\theta}_7) \\
& - 2m_7\dot{\xi}_2\dot{\theta}_1\dot{\theta}_7g_7 \sin(\theta_1 - \theta_7 - \beta) (\dot{\theta}_1 - \dot{\theta}_7)^2 \\
& + 2m_7\dot{\xi}_2\dot{\theta}_1\dot{\theta}_7g_7 \cos(\theta_1 - \theta_7 - \beta) (\ddot{\theta}_1 - \ddot{\theta}_7) \\
& - m_7\dot{\xi}_2\dot{\theta}_1^2g_7 \sin(\theta_1 - \theta_7 - \beta) - 4m_7\dot{\xi}_2\dot{\theta}_1\ddot{\theta}_1g_7 \sin(\theta_1 - \theta_7 - \beta) \\
& - 2m_7\dot{\xi}_2\ddot{\theta}_1^2g_7 \sin(\theta_1 - \theta_7 - \beta) - 2m_7\dot{\xi}_2\ddot{\theta}_1\dot{\theta}_1g_7 \sin(\theta_1 - \theta_7 - \beta) \\
& - 2m_7\dot{\xi}_2\dot{\theta}_1^2g_7 \cos(\theta_1 - \theta_7 - \beta) (\dot{\theta}_1 - \dot{\theta}_7) \\
& - 4m_7\dot{\xi}_2\dot{\theta}_1\ddot{\theta}_1g_7 \cos(\theta_1 - \theta_7 - \beta) (\dot{\theta}_1 - \dot{\theta}_7) \\
& + m_7\dot{\xi}_2\dot{\theta}_1^2g_7 \sin(\theta_1 - \theta_7 - \beta) (\dot{\theta}_1 - \dot{\theta}_7)^2 \\
& - m_7\dot{\xi}_2\dot{\theta}_1^2g_7 \cos(\theta_1 - \theta_7 - \beta) (\ddot{\theta}_1 - \ddot{\theta}_7) - m_7gg_7 \cos(\theta_7 + \beta) \dot{\theta}_7^2 \\
& - m_7gg_7 \sin(\theta_7 + \beta) \ddot{\theta}_7
\end{aligned}$$

$$\begin{aligned}
\ddot{Q}_5 = & -2m_7\ddot{\theta}_7^2 g_7 \cos(\theta_1 - \theta_7 - \beta) - 2m_7\xi_2\ddot{\theta}_7\dot{\theta}_7 g_7 \cos(\theta_1 - \theta_7 - \beta) \\
& + 4m_7\dot{\theta}_7\ddot{\theta}_7 g_7 \sin(\theta_1 - \theta_7 - \beta) (\dot{\theta}_1 - \dot{\theta}_7) \\
& + m_7\dot{\theta}_7^2 g_7 \cos(\theta_1 - \theta_7 - \beta) (\dot{\theta}_1 - \dot{\theta}_7)^2 \\
& + m_7\dot{\theta}_7^2 g_7 \sin(\theta_1 - \theta_7 - \beta) (\ddot{\theta}_1 - \ddot{\theta}_7) - m_2\xi_2\dot{\theta}_1^2 - 4m_2\xi_2\dot{\theta}_1\ddot{\theta}_1 - 2m_2(\xi_2 \\
& - a_2)\ddot{\theta}_1^2 - 2m_2(\xi_2 - a_2)\ddot{\theta}_1\dot{\theta}_1 - m_7\xi_2\dot{\theta}_1^2 - 4m_7\xi_2\dot{\theta}_1\ddot{\theta}_1 - 2m_7\xi_2\ddot{\theta}_1\dot{\theta}_1 \\
& + m_2g\ddot{\theta}_1\cos(\theta_1) - m_2g\dot{\theta}_1^2\sin(\theta_1) + m_7g\ddot{\theta}_1\cos(\theta_1) - m_7g\dot{\theta}_1^2\sin(\theta_1)
\end{aligned}$$

3 The First, Second and Third Time Derivatives of \hat{B}

$$\dot{B}_{11} = -\dot{\xi}_2 \sin(\theta_1) - \xi_2 \dot{\theta}_1 \cos(\theta_1)$$

$$\dot{B}_{12} = \dot{\xi}_4 \sin(\theta_3) + \xi_4 \dot{\theta}_3 \cos(\theta_3)$$

$$\dot{B}_{13} = 0$$

$$\dot{B}_{14} = -L_7 \dot{\theta}_7 \cos(\theta_7)$$

$$\dot{B}_{15} = -\dot{\theta}_1 \sin(\theta_1)$$

$$\dot{B}_{16} = \dot{\theta}_3 \sin(\theta_3)$$

$$\dot{B}_{17} = 0$$

$$\dot{B}_{21} = \dot{\xi}_2 \cos(\theta_1) - \xi_2 \dot{\theta}_1 \sin(\theta_1)$$

$$\dot{B}_{22} = -\dot{\xi}_4 \cos(\theta_3) + \xi_4 \dot{\theta}_3 \sin(\theta_3)$$

$$\dot{B}_{23} = 0$$

$$\dot{B}_{24} = -L_7 \dot{\theta}_7 \sin(\theta_7)$$

$$\dot{B}_{25} = \dot{\theta}_1 \cos(\theta_1)$$

$$\dot{B}_{26} = -\dot{\theta}_3 \cos(\theta_3)$$

$$\dot{B}_{27} = 0$$

$$\dot{B}_{31} = -\dot{\xi}_2 \sin(\theta_1) - \xi_2 \dot{\theta}_1 \cos(\theta_1)$$

$$\dot{B}_{32} = 0$$

$$\dot{B}_{33} = \dot{\xi}_6 \sin(\theta_5) + \xi_6 \dot{\theta}_5 \cos(\theta_5)$$

$$\dot{B}_{34} = -L_7 \dot{\theta}_7 \cos(\theta_7 + \alpha)$$

$$\dot{B}_{35} = -\dot{\theta}_1 \sin(\theta_1)$$

$$\dot{B}_{36} = 0$$

$$\dot{B}_{37} = \dot{\theta}_5 \sin(\theta_5)$$

$$\dot{B}_{41} = \dot{\xi}_2 \cos(\theta_1) - \xi_2 \dot{\theta}_1 \sin(\theta_1)$$

$$\begin{aligned}
\dot{B}_{42} &= 0 \\
\dot{B}_{43} &= -\dot{\xi}_6 \cos(\theta_5) + \xi_6 \dot{\theta}_5 \cos(\theta_5) \\
\dot{B}_{44} &= -L_7 \dot{\theta}_7 \sin(\theta_7 + \alpha) \\
\dot{B}_{45} &= \dot{\theta}_1 \cos(\theta_1) \\
\dot{B}_{46} &= 0 \\
\dot{B}_{47} &= -\dot{\theta}_5 \cos(\theta_5) \\
\ddot{B}_{11} &= -\ddot{\xi}_2 \sin(\theta_1) - 2\dot{\xi}_2 \dot{\theta}_1 \cos(\theta_1) - \xi_2 \ddot{\theta}_1 \cos(\theta_1) + \xi_2 \dot{\theta}_1^2 \sin(\theta_1) \\
\ddot{B}_{12} &= \ddot{\xi}_4 \sin(\theta_3) + 2\dot{\xi}_4 \dot{\theta}_3 \cos(\theta_3) + \xi_4 \ddot{\theta}_3 \cos(\theta_3) - \xi_4 \dot{\theta}_3^2 \sin(\theta_3) \\
\ddot{B}_{13} &= 0 \\
\ddot{B}_{14} &= -L_7 \ddot{\theta}_7 \cos(\theta_7) + L_7 \dot{\theta}_7^2 \sin(\theta_7) \\
\ddot{B}_{15} &= -\ddot{\theta}_1 \sin(\theta_1) - \dot{\theta}_1^2 \cos(\theta_1) \\
\ddot{B}_{16} &= \ddot{\theta}_3 \sin(\theta_3) + \dot{\theta}_3^2 \cos(\theta_3) \\
\ddot{B}_{17} &= 0 \\
\ddot{B}_{21} &= \ddot{\xi}_2 \cos(\theta_1) - 2\dot{\xi}_2 \dot{\theta}_1 \sin(\theta_1) - \xi_2 \ddot{\theta}_1 \sin(\theta_1) - \xi_2 \dot{\theta}_1^2 \cos(\theta_1) \\
\ddot{B}_{22} &= -\ddot{\xi}_4 \cos(\theta_3) + 2\dot{\xi}_4 \dot{\theta}_3 \sin(\theta_3) + \xi_4 \ddot{\theta}_3 \sin(\theta_3) + \xi_4 \dot{\theta}_3^2 \cos(\theta_3) \\
\ddot{B}_{23} &= 0 \\
\ddot{B}_{24} &= -L_7 \ddot{\theta}_7 \sin(\theta_7) - L_7 \dot{\theta}_7^2 \cos(\theta_7) \\
\ddot{B}_{25} &= \ddot{\theta}_1 \cos(\theta_1) - \dot{\theta}_1^2 \sin(\theta_1) \\
\ddot{B}_{26} &= -\ddot{\theta}_3 \cos(\theta_3) + \dot{\theta}_3^2 \sin(\theta_3) \\
\ddot{B}_{27} &= 0 \\
\ddot{B}_{31} &= -\ddot{\xi}_2 \sin(\theta_1) - 2\dot{\xi}_2 \dot{\theta}_1 \cos(\theta_1) - \xi_2 \ddot{\theta}_1 \cos(\theta_1) + \xi_2 \dot{\theta}_1^2 \sin(\theta_1) \\
\ddot{B}_{32} &= 0 \\
\ddot{B}_{33} &= \ddot{\xi}_6 \sin(\theta_5) + 2\dot{\xi}_6 \dot{\theta}_5 \cos(\theta_5) + \xi_6 \ddot{\theta}_5 \cos(\theta_5) - \xi_6 \dot{\theta}_5^2 \sin(\theta_5) \\
\ddot{B}_{34} &= -L_7 \ddot{\theta}_7 \cos(\theta_7 + \alpha) + L_7 \dot{\theta}_7^2 \sin(\theta_7 + \alpha) \\
\ddot{B}_{35} &= -\ddot{\theta}_1 \sin(\theta_1) - \dot{\theta}_1^2 \cos(\theta_1) \\
\ddot{B}_{36} &= 0 \\
\ddot{B}_{37} &= \ddot{\theta}_5 \sin(\theta_5) + \dot{\theta}_5^2 \cos(\theta_5) \\
\ddot{B}_{41} &= \ddot{\xi}_2 \cos(\theta_1) - 2\dot{\xi}_2 \dot{\theta}_1 \sin(\theta_1) - \xi_2 \ddot{\theta}_1 \sin(\theta_1) - \xi_2 \dot{\theta}_1^2 \cos(\theta_1) \\
\ddot{B}_{42} &= 0 \\
\ddot{B}_{43} &= -\ddot{\xi}_6 \cos(\theta_5) + 2\dot{\xi}_6 \dot{\theta}_5 \sin(\theta_5) + \xi_6 \ddot{\theta}_5 \sin(\theta_5) + \xi_6 \dot{\theta}_5^2 \cos(\theta_5) \\
\ddot{B}_{44} &= -L_7 \ddot{\theta}_7 \sin(\theta_7 + \alpha) - L_7 \dot{\theta}_7^2 \cos(\theta_7 + \alpha) \\
\ddot{B}_{45} &= \ddot{\theta}_1 \cos(\theta_1) - \dot{\theta}_1^2 \sin(\theta_1)
\end{aligned}$$

$$\ddot{B}_{46} = 0$$

$$\ddot{B}_{47} = -\ddot{\theta}_5 \cos(\theta_5) + \dot{\theta}_5^2 \sin(\theta_5)$$

$$\begin{aligned} \ddot{B}_{11} = & -\ddot{\xi}_2 \sin(\theta_1) - 3\ddot{\xi}_2 \dot{\theta}_1 \cos(\theta_1) - 3\dot{\xi}_2 \ddot{\theta}_1 \cos(\theta_1) - \xi_2 \ddot{\theta}_1 \cos(\theta_1) + 3\dot{\xi}_2 \dot{\theta}_1^2 \sin(\theta_1) \\ & + 3\dot{\xi}_2 \dot{\theta}_1 \ddot{\theta}_1 \sin(\theta_1) + \xi_2 \dot{\theta}_1^3 \cos(\theta_1) \end{aligned}$$

$$\begin{aligned} \ddot{B}_{12} = & \ddot{\xi}_4 \sin(\theta_3) + 3\dot{\xi}_4 \ddot{\theta}_3 \cos(\theta_3) + 3\ddot{\xi}_4 \dot{\theta}_3 \cos(\theta_3) - 3\dot{\xi}_4 \dot{\theta}_3^2 \sin(\theta_3) + \xi_4 \ddot{\theta}_3 \cos(\theta_3) \\ & - 3\dot{\xi}_4 \dot{\theta}_3 \ddot{\theta}_3 \sin(\theta_3) - \xi_4 \dot{\theta}_3^3 \cos(\theta_3) \end{aligned}$$

$$\ddot{B}_{13} = 0$$

$$\ddot{B}_{14} = -L_7 \ddot{\theta}_7 \cos(\theta_7) + 3L_7 \dot{\theta}_7 \ddot{\theta}_7 \sin(\theta_7) + L_7 \dot{\theta}_7^3 \cos(\theta_7)$$

$$\ddot{B}_{15} = -\ddot{\theta}_1 \sin(\theta_1) - 3\dot{\theta}_1 \ddot{\theta}_1 \cos(\theta_1) + \dot{\theta}_1^3 \sin(\theta_1)$$

$$\ddot{B}_{16} = \ddot{\theta}_3 \sin(\theta_3) + 3\dot{\theta}_3 \ddot{\theta}_3 \cos(\theta_3) - \dot{\theta}_3^3 \sin(\theta_3)$$

$$\ddot{B}_{17} = 0$$

$$\begin{aligned} \ddot{B}_{21} = & \ddot{\xi}_2 \cos(\theta_1) - 3\dot{\xi}_2 \dot{\theta}_1 \sin(\theta_1) - 3\ddot{\xi}_2 \ddot{\theta}_1 \sin(\theta_1) - 3\dot{\xi}_2 \dot{\theta}_1^2 \cos(\theta_1) - \xi_2 \ddot{\theta}_1 \sin(\theta_1) \\ & - 3\dot{\xi}_2 \dot{\theta}_1 \ddot{\theta}_1 \cos(\theta_1) + \xi_2 \dot{\theta}_1^3 \sin(\theta_1) \end{aligned}$$

$$\begin{aligned} \ddot{B}_{22} = & -\ddot{\xi}_4 \cos(\theta_3) + 3\dot{\xi}_4 \ddot{\theta}_3 \sin(\theta_3) + 3\ddot{\xi}_4 \dot{\theta}_3 \sin(\theta_3) + 3\dot{\xi}_4 \dot{\theta}_3^2 \cos(\theta_3) + \xi_4 \ddot{\theta}_3 \sin(\theta_3) \\ & + 3\dot{\xi}_4 \dot{\theta}_3 \ddot{\theta}_3 \cos(\theta_3) - \xi_4 \dot{\theta}_3^3 \sin(\theta_3) \end{aligned}$$

$$\ddot{B}_{23} = 0$$

$$\ddot{B}_{24} = -L_7 \ddot{\theta}_7 \sin(\theta_7) - 3L_7 \dot{\theta}_7 \ddot{\theta}_7 \cos(\theta_7) + L_7 \dot{\theta}_7^3 \sin(\theta_7)$$

$$\ddot{B}_{25} = \ddot{\theta}_1 \cos(\theta_1) - 3\dot{\theta}_1 \ddot{\theta}_1 \cos(\theta_1) - \dot{\theta}_1^3 \sin(\theta_1)$$

$$\ddot{B}_{26} = -\ddot{\theta}_3 \cos(\theta_3) + 3\dot{\theta}_3 \ddot{\theta}_3 \cos(\theta_3) + \dot{\theta}_3^3 \cos(\theta_3)$$

$$\ddot{B}_{27} = 0$$

$$\begin{aligned} \ddot{B}_{31} = & -\ddot{\xi}_2 \sin(\theta_1) - 3\dot{\xi}_2 \dot{\theta}_1 \cos(\theta_1) - 3\ddot{\xi}_2 \ddot{\theta}_1 \cos(\theta_1) - \xi_2 \ddot{\theta}_1 \cos(\theta_1) + 3\dot{\xi}_2 \dot{\theta}_1^2 \sin(\theta_1) \\ & + 3\dot{\xi}_2 \dot{\theta}_1 \ddot{\theta}_1 \sin(\theta_1) + \xi_2 \dot{\theta}_1^3 \cos(\theta_1) \end{aligned}$$

$$\ddot{B}_{32} = 0$$

$$\begin{aligned} \ddot{B}_{33} = & \ddot{\xi}_6 \sin(\theta_5) + 3\dot{\xi}_6 \ddot{\theta}_5 \cos(\theta_5) + 3\ddot{\xi}_6 \dot{\theta}_5 \cos(\theta_5) - 3\dot{\xi}_6 \dot{\theta}_5^2 \sin(\theta_5) + \xi_6 \ddot{\theta}_5 \cos(\theta_5) \\ & - 3\dot{\xi}_6 \dot{\theta}_5 \ddot{\theta}_5 \sin(\theta_5) - \xi_6 \dot{\theta}_5^3 \cos(\theta_5) \end{aligned}$$

$$\ddot{B}_{34} = -L_7 \ddot{\theta}_7 \cos(\theta_7 + \alpha) + 3L_7 \dot{\theta}_7 \ddot{\theta}_7 \sin(\theta_7 + \alpha) + L_7 \dot{\theta}_7^3 \cos(\theta_7 + \alpha)$$

$$\ddot{B}_{35} = -\ddot{\theta}_1 \sin(\theta_1) - 3\dot{\theta}_1 \ddot{\theta}_1 \cos(\theta_1) + \dot{\theta}_1^3 \sin(\theta_1)$$

$$\ddot{B}_{36} = 0$$

$$\ddot{B}_{37} = \ddot{\theta}_5 \sin(\theta_5) + 3\dot{\theta}_5 \ddot{\theta}_5 \cos(\theta_5) - \dot{\theta}_5^3 \sin(\theta_5)$$

$$\begin{aligned}\ddot{B}_{41} = & \ddot{\xi}_2 \cos(\theta_1) - 3\dot{\xi}_2 \dot{\theta}_1 \sin(\theta_1) - 3\dot{\xi}_2 \ddot{\theta}_1 \sin(\theta_1) - \xi_2 \ddot{\theta}_1 \sin(\theta_1) - 3\dot{\xi}_2 \dot{\theta}_1^2 \cos(\theta_1) \\ & - 3\dot{\xi}_2 \dot{\theta}_1 \ddot{\theta}_1 \cos(\theta_1) + \xi_2 \dot{\theta}_1^3 \sin(\theta_1)\end{aligned}$$

$$\ddot{B}_{42} = 0$$

$$\begin{aligned}\ddot{B}_{43} = & -\ddot{\xi}_6 \cos(\theta_5) - 3\dot{\xi}_6 \ddot{\theta}_5 \sin(\theta_5) - 3\dot{\xi}_6 \dot{\theta}_5 \sin(\theta_5) - 3\dot{\xi}_6 \dot{\theta}_5^2 \sin(\theta_5) + \xi_6 \ddot{\theta}_5 \sin(\theta_5) \\ & - 3\dot{\xi}_6 \dot{\theta}_5 \ddot{\theta}_5 \cos(\theta_5) - \xi_6 \dot{\theta}_5^3 \sin(\theta_5)\end{aligned}$$

$$\ddot{B}_{44} = -L_7 \ddot{\theta}_7 \sin(\theta_7 + \alpha) + 3L_7 \dot{\theta}_7 \ddot{\theta}_7 \cos(\theta_7 + \alpha) + L_7 \dot{\theta}_7^3 \sin(\theta_7 + \alpha)$$

$$\ddot{B}_{45} = \ddot{\theta}_1 \cos(\theta_1) - 3\dot{\theta}_1 \ddot{\theta}_1 \sin(\theta_1) - \dot{\theta}_1^3 \cos(\theta_1)$$

$$\ddot{B}_{46} = 0$$

$$\ddot{B}_{47} = -\ddot{\theta}_5 \cos(\theta_5) - 3\dot{\theta}_5 \ddot{\theta}_5 \sin(\theta_5) + \dot{\theta}_5^3 \cos(\theta_5)$$

4 The First, Second and Third Time Derivatives of \widehat{G}

$$\dot{G}_{11} = -\dot{\xi}_2 \sin(\theta_1) - \xi_2 \dot{\theta}_1 \cos(\theta_1)$$

$$\dot{G}_{12} = 0$$

$$\dot{G}_{13} = 0$$

$$\dot{G}_{14} = -g_7 \dot{\theta}_7 \cos(\theta_7 + \beta)$$

$$\dot{G}_{15} = -\dot{\theta}_1 \sin(\theta_1)$$

$$\dot{G}_{16} = 0$$

$$\dot{G}_{17} = 0$$

$$\dot{G}_{21} = \dot{\xi}_2 \cos(\theta_1) - \xi_2 \dot{\theta}_1 \sin(\theta_1)$$

$$\dot{G}_{22} = 0$$

$$\dot{G}_{23} = 0$$

$$\dot{G}_{24} = -g_7 \dot{\theta}_7 \sin(\theta_7 + \beta)$$

$$\dot{G}_{25} = \dot{\theta}_1 \cos(\theta_1)$$

$$\dot{G}_{26} = 0$$

$$\dot{G}_{27} = 0$$

$$\dot{G}_{31} = 0$$

$$\dot{G}_{32} = 0$$

$$\dot{G}_{33} = 0$$

$$\dot{G}_{34} = 0$$

$$\dot{G}_{35} = 0$$

$$\dot{G}_{36} = 0$$

$$\dot{G}_{37} = 0$$

$$\ddot{G}_{11} = -\dot{\xi}_2 \sin(\theta_1) - 2\dot{\xi}_2 \dot{\theta}_1 \cos(\theta_1) - \xi_2 \ddot{\theta}_1 \cos(\theta_1) + \xi_2 \dot{\theta}_1^2 \cos(\theta_1)$$

$$\ddot{G}_{12} = 0$$

$$\ddot{G}_{13} = 0$$

$$\ddot{G}_{14} = -g_7 \ddot{\theta}_7 \cos(\theta_7 + \beta) + g_7 \dot{\theta}_7^2 \sin(\theta_7 + \beta)$$

$$\ddot{G}_{15} = -\ddot{\theta}_1 \sin(\theta_1) - \dot{\theta}_1^2 \cos(\theta_1)$$

$$\ddot{G}_{16} = 0$$

$$\ddot{G}_{17} = 0$$

$$\ddot{G}_{21} = \dot{\xi}_2 \cos(\theta_1) - 2\dot{\xi}_2 \dot{\theta}_1 \sin(\theta_1) - \xi_2 \ddot{\theta}_1 \sin(\theta_1) - \xi_2 \dot{\theta}_1^2 \cos(\theta_1)$$

$$\ddot{G}_{22} = 0$$

$$\ddot{G}_{23} = 0$$

$$\ddot{G}_{24} = -g_7 \ddot{\theta}_7 \sin(\theta_7 + \beta) - g_7 \dot{\theta}_7^2 \cos(\theta_7 + \beta)$$

$$\ddot{G}_{25} = \ddot{\theta}_1 \cos(\theta_1) - \dot{\theta}_1^2 \sin(\theta_1)$$

$$\ddot{G}_{26} = 0$$

$$\ddot{G}_{27} = 0$$

$$\ddot{G}_{31} = 0$$

$$\ddot{G}_{32} = 0$$

$$\ddot{G}_{33} = 0$$

$$\ddot{G}_{34} = 0$$

$$\ddot{G}_{35} = 0$$

$$\ddot{G}_{36} = 0$$

$$\ddot{G}_{37} = 0$$

$$\begin{aligned} \ddot{G}_{11} = & -\ddot{\xi}_2 \sin(\theta_1) - 3\dot{\xi}_2 \dot{\theta}_1 \cos(\theta_1) - 3\dot{\xi}_2 \ddot{\theta}_1 \cos(\theta_1) - \xi_2 \ddot{\theta}_1 \cos(\theta_1) + 3\xi_2 \dot{\theta}_1 \dot{\theta}_1 \sin(\theta_1) \\ & + 3\dot{\xi}_2 \dot{\theta}_1^2 \sin(\theta_1) + \xi_2 \dot{\theta}_1^3 \cos(\theta_1) \end{aligned}$$

$$\ddot{G}_{12} = 0$$

$$\ddot{G}_{13} = 0$$

$$\ddot{G}_{14} = -g_7 \ddot{\theta}_7 \cos(\theta_7 + \beta) + 3g_7 \dot{\theta}_7 \ddot{\theta}_7 \sin(\theta_7 + \beta) + g_7 \dot{\theta}_7^3 \cos(\theta_7 + \beta)$$

$$\ddot{G}_{15} = -\ddot{\theta}_1 \sin(\theta_1) - 3\ddot{\theta}_1 \dot{\theta}_1 \cos(\theta_1) + \dot{\theta}_1^3 \sin(\theta_1)$$

$$\ddot{G}_{16} = 0$$

$$\ddot{G}_{17} = 0$$

$$\ddot{G}_{21} = \ddot{\xi}_2 \cos(\theta_1) - 3\dot{\xi}_2 \dot{\theta}_1 \sin(\theta_1) - 3\dot{\xi}_2 \dot{\theta}_1 \sin(\theta_1) - \xi_2 \ddot{\theta}_1 \sin(\theta_1) - 3\xi_2 \dot{\theta}_1 \dot{\theta}_1 \cos(\theta_1) \\ - 3\dot{\xi}_2 \dot{\theta}_1^2 \cos(\theta_1) + \xi_2 \dot{\theta}_1^3 \sin(\theta_1)$$

$$\ddot{G}_{22} = 0$$

$$\ddot{G}_{23} = 0$$

$$\ddot{G}_{24} = -g_7 \ddot{\theta}_7 \sin(\theta_7 + \beta) - 3g_7 \dot{\theta}_7 \ddot{\theta}_7 \cos(\theta_7 + \beta) + g_7 \dot{\theta}_7^3 \sin(\theta_7 + \beta)$$

$$\ddot{G}_{25} = \ddot{\theta}_1 \cos(\theta_1) - 3\dot{\theta}_1 \dot{\theta}_1 \sin(\theta_1) - \dot{\theta}_1^3 \cos(\theta_1)$$

$$\ddot{G}_{26} = 0$$

$$\ddot{G}_{27} = 0$$

$$\ddot{G}_{31} = 0$$

$$\ddot{G}_{32} = 0$$

$$\ddot{G}_{33} = 0$$

$$\ddot{G}_{34} = 0$$

$$\ddot{G}_{35} = 0$$

$$\ddot{G}_{36} = 0$$

$$\ddot{G}_{37} = 0$$